



Specifications are subject to change without notice.



GUANGZHOU SANJING ELECTRIC CO.,LTD

Tel: (86)20 66608588 Fax: (86)20 66608589 Web: www.saj-electric.com Add: SAJ Innovation Park, No.9, Lizhishan Road, Science City, Guangzhou High-tech Zone, Guangdong, P.R.China



V1.0

C6-50K-T6-LV / C6-60K-T9-LV / C6-70K-T12-LV / C6-75K-T6 / C6-100K-T9 / C6-110K-T12 / C6-125K-T12

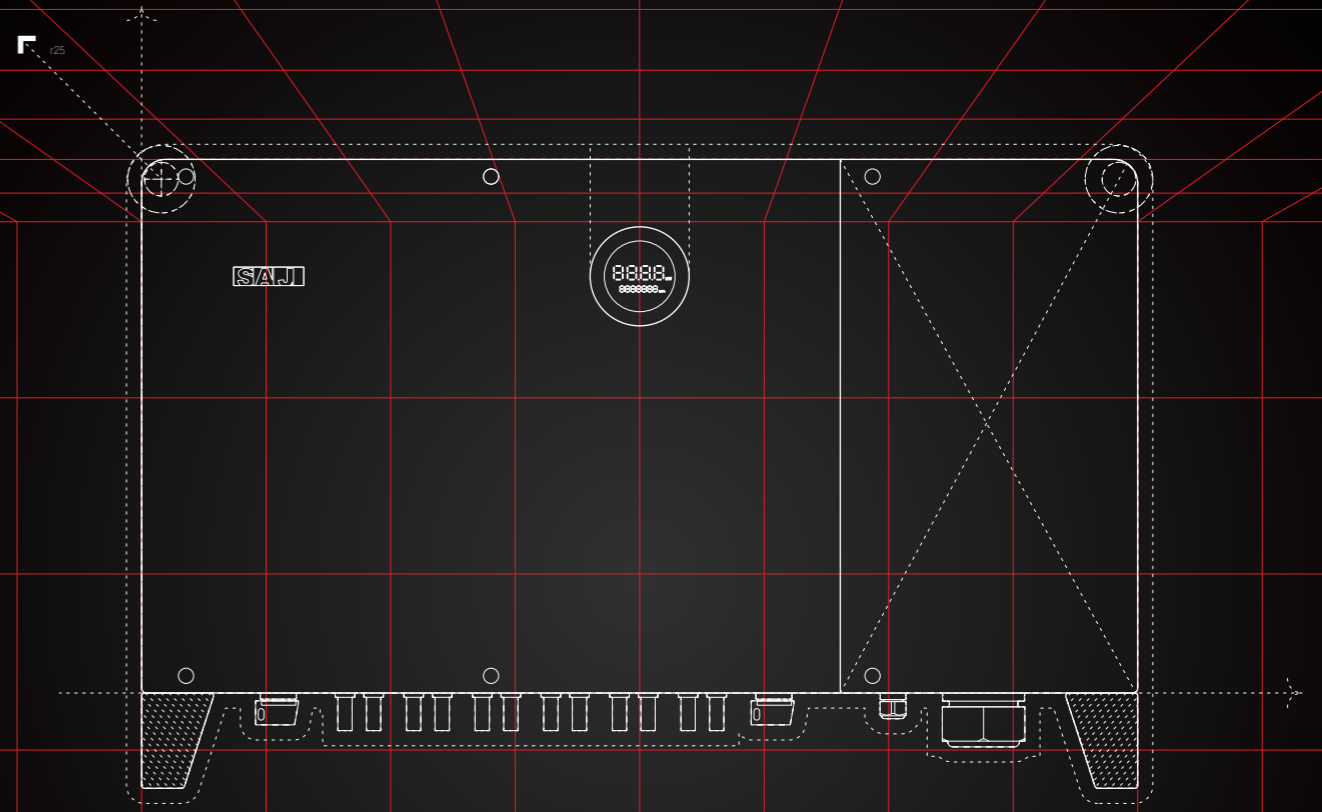

C6 series

COMMERCIAL ON-GRID SOLAR INVERTER User Manual



The World's Leading Provider of Digital Energy
Management Services for Green Buildings

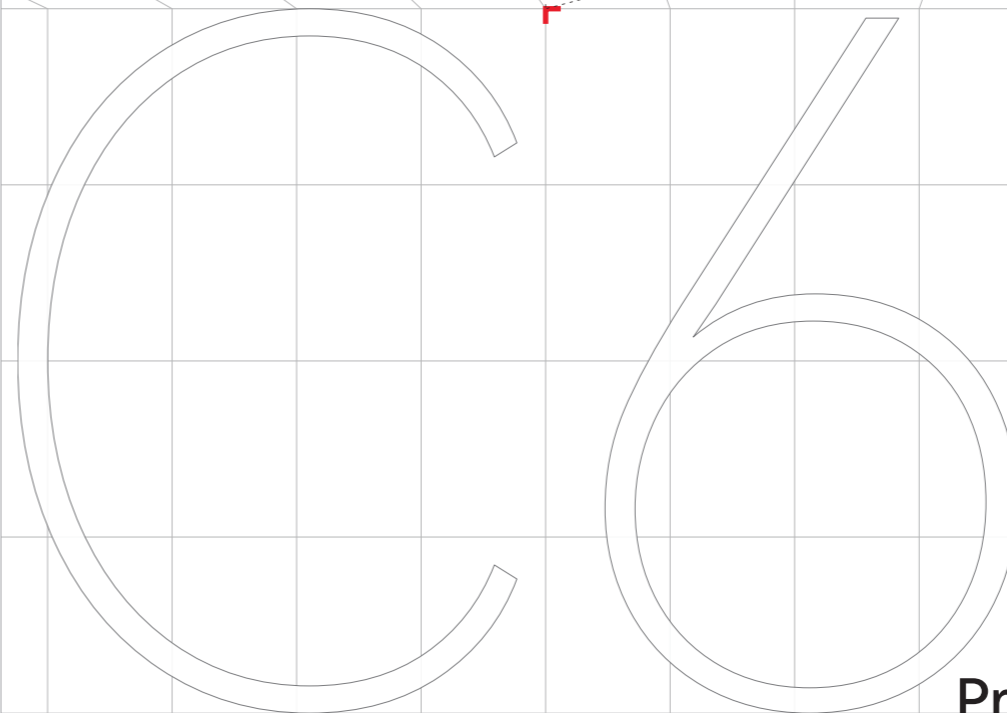











Preface

Thank you for choosing SAJ solar inverter. We are pleased to provide you first-class products and exceptional service. This manual includes information for installation, operation, maintenance, trouble shooting and safety. Please follow the instructions of this manual so that we can ensure delivery of our professional guidance and wholehearted service. Customer-orientation is our forever commitment. We hope this document proves to be of great assistance in your journey for a cleaner, greener world. Please check for the latest version at www.saj-electric.com

Guangzhou Sanjing Electric Co., Ltd.

Contents

	1. SAFETY PRECAUTIONS -----P3		5.3 AC Connection ----- P27
	1.1 Scope of Application ----- P4		5.3.1 Electrical Connection Overview ----- P27
	1.2 Safety Instruction ----- P4		5.3.3 Circuit Breaker Specification ----- P27
	1.3 Target Group ----- P4		5.3.4 OT/OD Terminal Specification ----- P28
	2. SYMBOLS -----P5		5.3.5 Connection of Additional Grounding ----- P28
	2.1 Symbols -----P6		5.3.6 AC Side Electrical Connection ----- P29
	2.2 Explanations of Symbols ----- P7		5.4 DC Side Electrical Connection ----- P30
	3. PRODUCT INFORMTION -----P9		5.4.1 DC cable specification ----- P30
	3.1 Application Scope of Products ----- P10		5.4.2 PV Connector Assembly ----- P30
	3.2 Specification for Product Model ----- P11		5.5 Communication Connection ----- P32
	3.3 Overview of products ----- P11		5.5.1 Communication Terminal Overview ----- P32
	3.4 Dimensions of products ----- P11		5.5.2 Dry Contact Connection ----- P32
	3.5 Datasheet ----- P12		5.6 RS485 Communication Connection ----- P34
	4. INSTRUCTION FOR INSTALLATION ----- P15		5.7 RS232/USB connection ----- P36
	4.1 Safety Instruction ----- P20		6. COMMISSIONING ----- P37
	4.2 Pre-installation Check ----- P20		6.1 Introduction of Human-computer Interface-- P38
	4.2.1 Check the Package ----- P20		6.2 Installer APP Installation ----- P39
	4.2.2 Scope of Delivery ----- P20		6.2.1 Nearby Monitoring ----- P39
	4.3 The Determination of the Installation Method and Position ----- P20		6.2.2 Initial set up ----- P40
	4.4 Mounting Procedure ----- P21		7. FAULT CODE AND TROUBLESHOOTING ----- P41
	4.4.1 Wall Mounting ----- P21		7.1 fault code ----- P42
	4.4.2 Bracket Installation ----- P23		7.2 troubleshooting ----- P43
	5. ELECTRICAL CONNECTION ----- P25		8. ROUTINE MAINTENANCE ----- P45
	5.1 Safety Instruction ----- P26		Inverter Cleaning ----- P46
	5.2 Specification for Electrical Interface ----- P26		Heat Sink Cleaning ----- P46
			9. RECYCLING AND DISPOSAL ----- P47



Safety Precautions

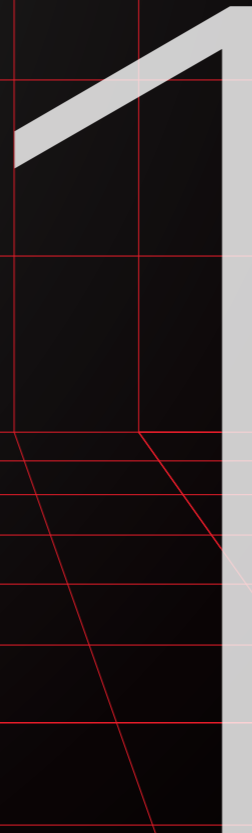

1.1 Safety Precautions

1.1 Scope of Application

This User Manual describes instructions and detailed procedures for installing, operating, maintaining, and troubleshooting of the following SAJ on-grid inverter

**C6-75K-T6 / C6-100K-T9 / C6-110K-T12 / C6-125K-T12
C6-50K-T6-LV, C6-60K-T9-LV, C6-70K-T12-LV**

Please keep this manual all time available in case of emergency.

1.2 Safety Instruction

 DANGER
· DANGER indicates a hazardous situation, which, if not avoided, will result in death or serious injury.

 WARNING
· WARNING indicates a hazardous situation, which, if not avoided, can result in death or serious injury or moderate injury.

 CAUTION
· CAUTION indicates a hazardous condition, which, if not avoided, can result in minor or moderate injury.

 NOTICE
· NOTICE indicates a situation that can result in potential damage, if not avoided.

1.3 Target Group

Only qualified electricians who have read and fully understood all safety regulations contained in this manual can install, maintain and repair the inverter. Operators must be aware of the high-voltage device.



Symbols

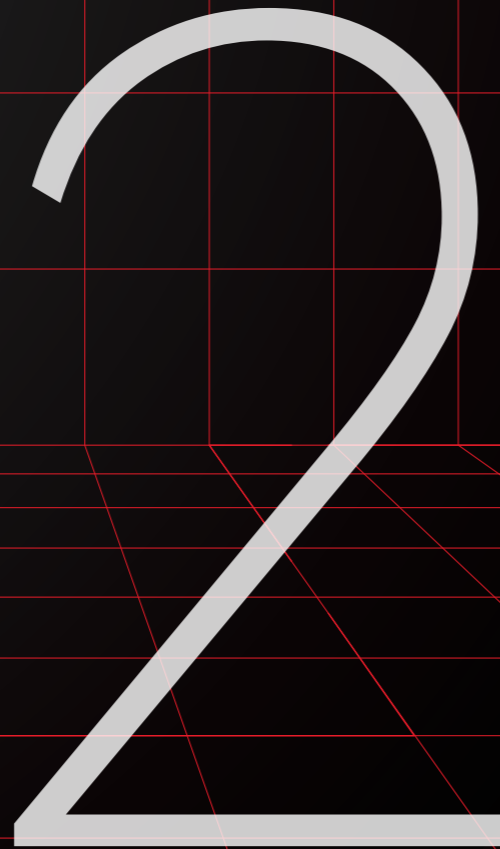

2.1 Symbols

⚠ DANGER

- There is possibility of danger to life due to electrical shock and high voltage.
- Do not touch non-insulated parts or cables.
- Disconnect the inverter from voltage sources and make sure it cannot be reconnected before working on the device.
- Do not disconnect the DC connector under load.
- Do not touch the live parts and cables inside the inverter during operation, it might result in burning or death.
- To prevent risk of electric shock during installation and maintenance, please make sure that all AC and DC terminals are disconnected.
- Do not touch the surface of the inverter while the housing is wet, otherwise, it might cause electrical shock.
- Do not stay close to the inverter while there are severe weather conditions including storm, lightning, etc.
- Before opening the housing, the SAJ inverter must be disconnected from the grid and PV generator; you must wait for at least five minutes to let the energy storage capacitors completely discharged after disconnecting from power source.

⚠ WARNING

Danger to life due to fire or explosion

- In the event of fault, do not conduct any direct action on the inverter.
- Disconnect PV array from inverter via an external disconnection device. If there is no external disconnection device present, wait until no more DC power is applied to the inverter.
- Disconnect the AC circuit breaker, or keep it disconnect if it is tripped, and secure it against reconnection.
- Do not touch non-insulated parts or cables.
- Do not touch non-insulated parts or cables.
- The installation, service, recycling and disposal of the inverters must be performed by qualified personnel only in compliance with national and local standards and regulations.
- Any unauthorized actions including modification of product functionality of any form may cause lethal hazard to the operator, third parties, the units or their property. SAJ is not responsible for the loss and these warranty claims.
- The SAJ inverter must only be operated with PV generator. Do not connect any other source of energy to the SAJ inverter.
- Be sure that the PV generator and inverter are well grounded in order to protect properties and persons.

⚠ CAUTION

- The solar inverter enclosure will become hot during operation. Please do not touch the heat sink or enclosure during operation.
- Risk of damage due to improper modifications.

⚠ NOTICE

- Public utility only.
- The solar inverter is designed to feed AC power directly to the public utility power grid; do not connect AC output of the inverter to any private AC equipment.

2.2

Explanations of Symbols

Symbol	Description
	Dangerous electrical voltage This device is directly connected to public grid, thus all work to the inverter shall only be carried out by qualified personnel.
	Danger to life due to high electrical voltage! There might be residual currents in inverter because of large capacitors. Wait for 5 minutes before you remove the front lid.
	Notice, danger! This is directly connected with electricity generators and public grid.
	Danger of hot surface The components inside the inverter will release a lot of heat during operation. Do not touch metal plate housing during operating.
	An error has occurred Please go to Chapter 9 "Troubleshooting" to remedy the error.
	This device shall not be disposed of in residential waste Please go to Chapter 8 "Recycling and Disposal" for proper treatments.
	CE Mark Equipment with the CE mark fulfills the basic requirements of the Guideline Governing Low-Voltage and Electro-magnetic Compatibility.
	CQC Mark The inverter complies with the safety instructions from China's Quality Center.

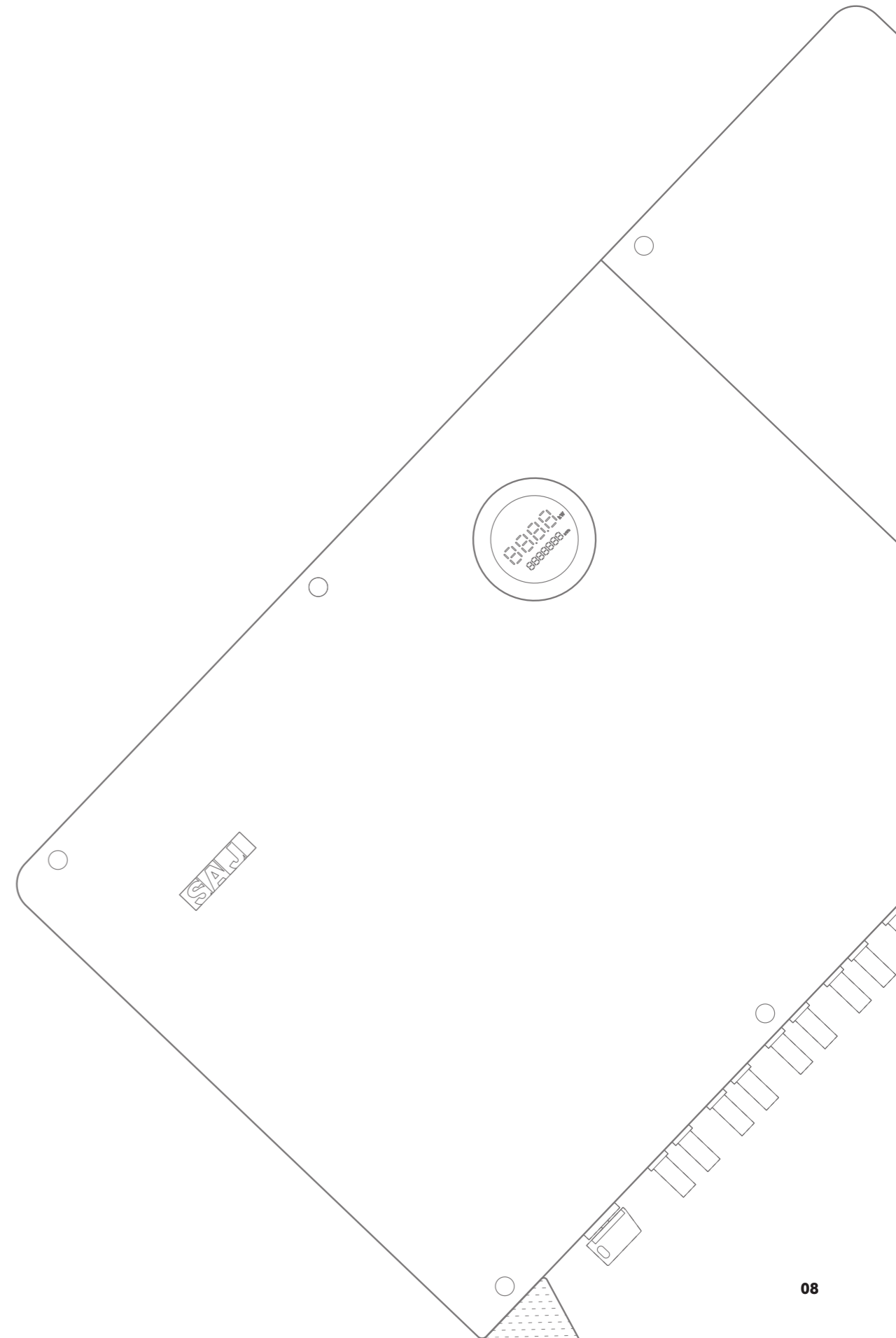



Product Information

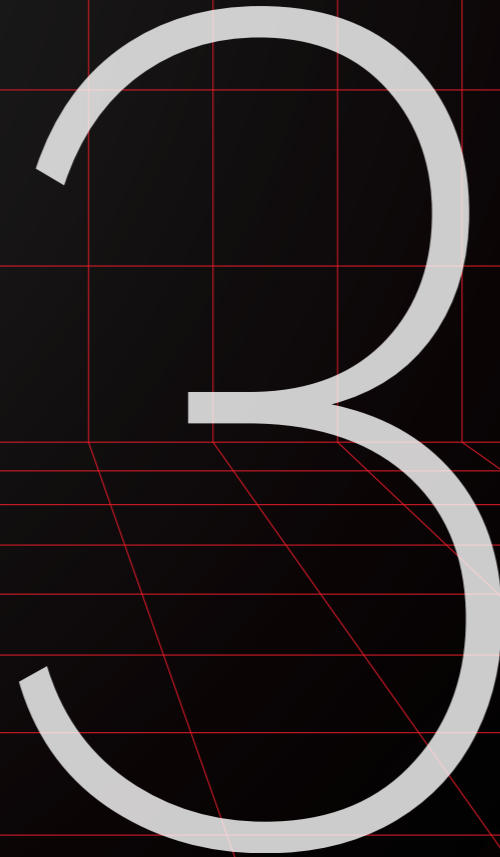

3.1

Application Scope of Products

C6 series product is grid-tied three phase inverter without transformer. The product converts the DC generated by solar panels into AC which is in accordance with the requirements of public grid and send the AC into the grid, Figure 3.1 shows the structural diagram of the typical application system of C6 inverter.

Figure 3.1
C6 series application

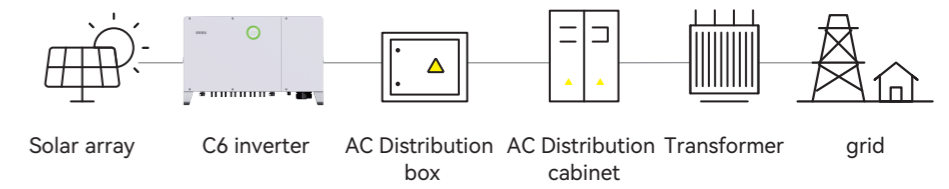

C6 Applicable Grid

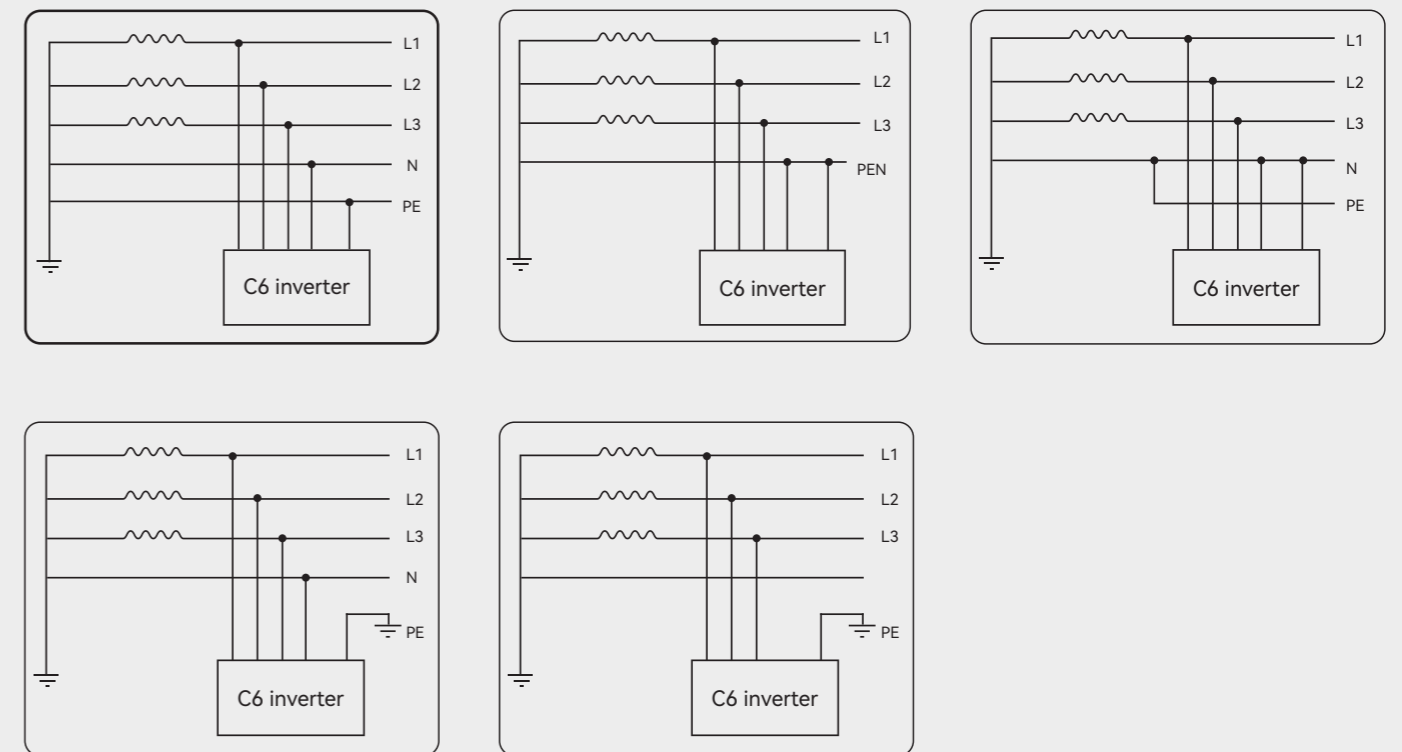

Figure 3.2
C6 applicable grid

3.2 Specification for Product Model

C6 - XK - TX - LV
 ① ② ③ ④

- ① C6 means for product name.
- ② XK means rated power XkW of inverter, for example, 125K means 125kW.
- ③ T means three phase; X represents the number of MPPT of inverter
- ④ LV means that the AC output voltage is 220V; If no LV suffix, AC output voltage is 380V/400V

3.3 Overview of products

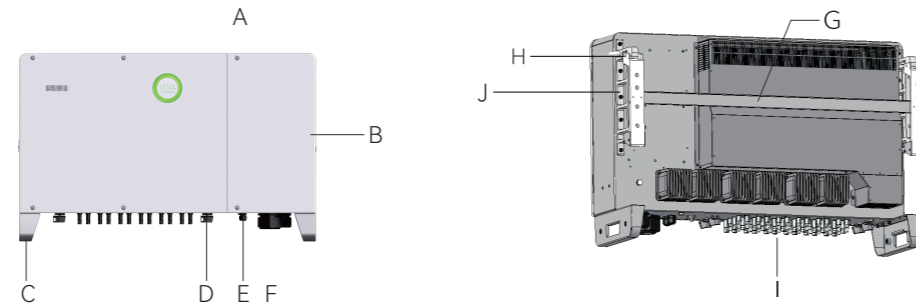

Item	Name
A	LED Display Board
B	Wiring Cabinet Cover
C	Handle (Base)
D	DC Switch
E	Communication Port
F	AC Output
G	Mounting Bracket (Beam)
H	Mounting Bracket (side hanger)
I	DC Input
J	Handel (Side)

3.4 Dimensions of products

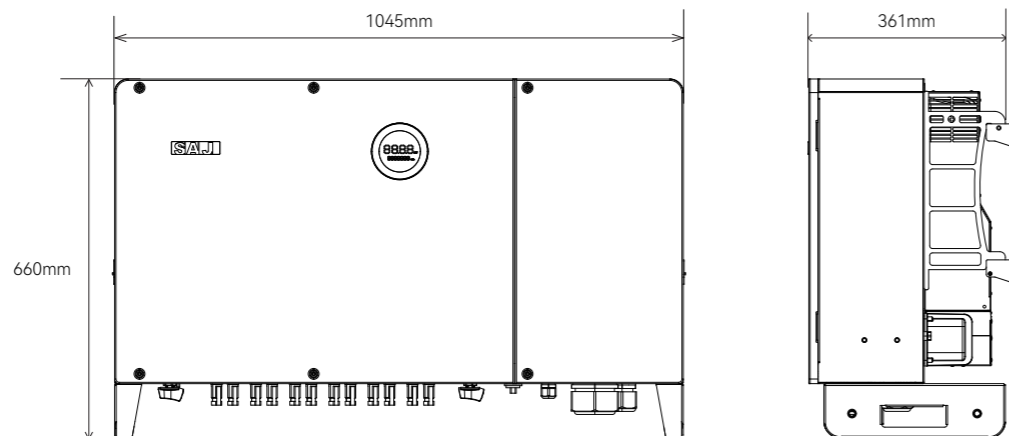

3.5 Datasheet

C6-75K/100K/110K/125K-T6/T9/T12

Model	C6-75K-T6	C6-100K-T9	C6-110K-T12	C6-125K-T12
Input (DC)				
Max. PV Array Power[kWp]@STC	112.5	150	165	180
Max. Input Voltage[V]	1100			
MPP Voltage Range[V]	180 ~ 1000			
Nominal Input Voltage[V]	600			
Startup Voltage[V]	200			
Min. Input Voltage[V]	180			
Max. Input Current[A]	6*30	9*30	12*30	
Max. Short-Circuit Current[A]	6*45	9*45	12*45	
Number of Strings per MPP Tracker	2			
Number of MPP Trackers	6	9	12	
DC Switch	Integrated			
Output (AC)				
Rated AC Output Power[kW]	75	100	110	125
Max. AC Output Power[kW]	82.5	110	121	125
Max. AC Apparent Power[kVA]	82.5	110	121	125
Rated AC Output Current[A]	108.3	144.3	158.8	180.4
Max. AC Output Current[A]	119.1	158.8	174.6	180.4
Nominal AC Voltage[V]	3+N+PE,230/400			
Nominal AC Grid Frequency/ Range [Hz]	50, 60 / 44-55, 54-65			
Total Distortion Harmonic[THDi]	<3%			
Adjustable Power Factor	0.8 leading ~ 0.8 lagging			
Feed-in phases/AC connection phases	3/3			
Efficiency				
Max. Efficiency	98.8%			
Euro. Efficiency	98.5%			

Model	C6-75K-T6	C6-100K-T9	C6-110K-T12	C6-125K-T12
Protection				
PV String Current Monitoring	Integrated			
Internal Temperature Detection	Integrated			
Residual Current Monitoring Unit	Integrated			
DC Insulation Resistance Detection	Integrated			
Anti-islanding Protection	Integrated			
DC Reverse Polarity Protection	Integrated			
DC Surge Protection	Type II			
AC Surge Protection	Type II			
AC Overcurrent Protection	Integrated			
AC Short-Circuit Protection	Integrated			
AC Overvoltage Protection	Integrated			
AFCI Protection	Optional			
PID Recovery	Optional			
Interface				
AC Connection	OT/DT Terminal (Max. 240 mm ²)			
DC Connection	MC4			
Display	LED+APP (Bluetooth)			
Communication Port	RS232+RS485			
Communication Mode	Wi-Fi/Ethernet/4G/PLC(Optional)			
General Data				
Topology	Non-isolated			
Nighttime Power Consumption[W]	<2			
Operating Temperature Range	-30°C ~ +60°C [45°C to 60°C with derating]			
Cooling Method	Intelligent fan cooling			
Ambient Humidity Max. Operating Altitude[m]	0% ~ 100% non-condensing4000 (>3000 power derating)			

Model	C6-75K-T6	C6-100K-T9	C6-110K-T12	C6-125K-T12
General Data				
Noise[dBA]	<60			
Ingress Protection	IP66			
Mounting	Wall mounting			
Dimensions [H*W*D][mm]	1045*660*361			
Weight[kg]	93		98	
Warranty[Year]	5(Standard)/10/15/20 (Optional)			
Certifications	EN50549-2,IEC/EN62109-1/2 EN61000-6-2/4,PPDS, RD1669,RD413, UNE217001,IEC 62116, IEC61727,G99, CEI 0-16, C10/11			

C6-50K-T6-LV,C6-60K-T9-LV,C6-70-T12-LV

Model	C6-50K-T6-LV	C6-60K-T9-LV	C6-70K-T12-LV
Input (DC)			
Max. PV Array Power[kWp]@STC	75	90	105
Max. Input Voltage[V]	1100		
MPP Voltage Range[V]	180 ~ 1000		
Nominal Input Voltage[V]	380		
Startup Voltage[V]	200		
Min. Input Voltage[V]	180		
Max. Input Current[A]	6*30	9*30	12*30
Max. Short-Circuit Current[A]	6*45	9*45	12*45
Number of Strings per MPP Tracker	2		
Number of MPP Trackers	6	9	12
DC Switch	Integrated		
Output (AC)			
Rated AC Output Power[kW]	50	60	70
Max. AC Output Power[kW]	55	60	70
Max. AC Apparent Power[kVA]	55	60	70
Rated AC Output Current[A]	131.2	157.5	183.7
Max. AC Output Current[A]	144.3	157.5	183.7
Nominal AC Voltage[V]	3+N+PE,127/220		
Nominal AC Grid Frequency/ Range [Hz]	50, 60/44-55, 54-65		
Total Distortion Harmonic[THDi]	<3%		
Adjustable Power Factor	0.8 leading ~ 0.8 lagging		
Feed-in phases/AC connection phases	3/3		
Efficiency			
Max. Efficiency	98.8%		
Euro. Efficiency	98.5%		

Model	C6-50K-T6-LV	C6-60K-T9-LV	C6-70K-T12-LV
Protection			
PV String Current Monitoring	Integrated		
Internal Temperature Detection	Integrated		
Residual Current Monitoring Unit	Integrated		
DC Insulation Resistance Detection	Integrated		
Anti-islanding Protection	Integrated		
DC Reverse Polarity Protection	Integrated		
DC Surge Protection	Type II		
AC Surge Protection	Type II		
AC Overcurrent Protection	Integrated		
AC Short-Circuit Protection	Integrated		
AC Overvoltage Protection	Integrated		
AFCI Protection	Optional		
PID Recovery	Optional		
Interface			
AC Connection	OT/DT Terminal (Max. 240 mm ²)		
DC Connection	MC4		
Display	LED+APP (Bluetooth)		
Communication Port	RS232+RS485		
Communication Mode	Wi-Fi/Ethernet/4G/PLC(Optional)		
General Data			
Topology	Non-isolated		
Nighttime Power Consumption[W]	<2		
Operating Temperature Range	-30°C ~ +60°C [45°C to 60°C with derating]		
Cooling Method	Intelligent Fan Cooling		
Ambient Humidity	0% ~ 100% Non-condensing		

Model	C6-50K-T6-LV	C6-60K-T9-LV	C6-70K-T12-LV
General Data			
Max. Operating Altitude[m]	4000 (>3000 Power Derating)		
Noise[dBA]	<60		
Ingress Protection	IP66		
Mounting	Wall mounting		
Dimensions [H*W*D][mm]	660*1045*361		
Weight[kg]	93		98
Warranty[Year]	5(Standard)/10/15/20 (Optional)		
Certifications	IEC/EN62109-1/2, EN61000-6-1/2/3/4		

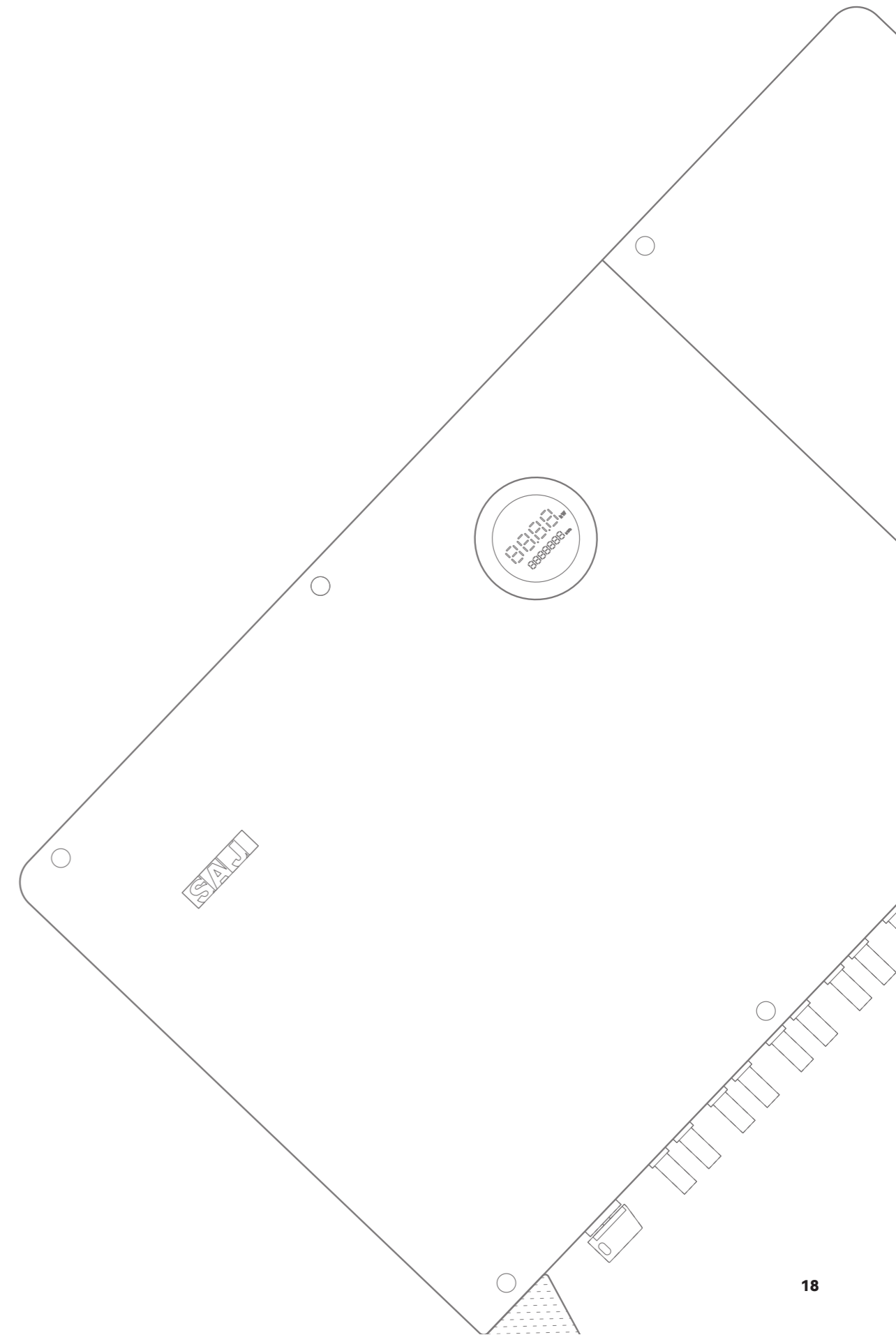

Instruction for Installation

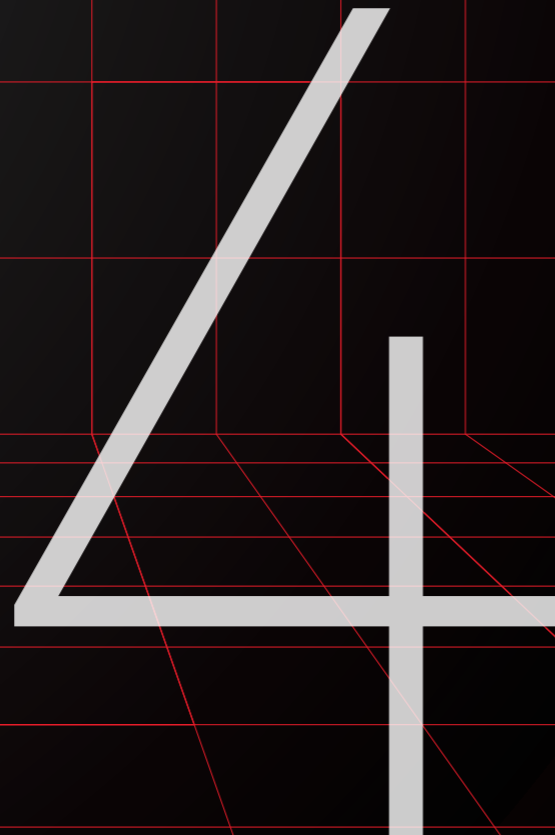

4.1

Safety Instruction

DANGER
<ul style="list-style-type: none"> · Dangerous to life due to potential fire or electricity shock. · Do not install the inverter near any inflammable or explosive items. · This inverter will be directly connected with HIGH VOLTAGE power generation device; the installation must be performed by qualified personnel only in compliance with national and local standards and regulations.
NOTICE
<ul style="list-style-type: none"> · This equipment meets the pollution degree II. · Inappropriate installation environment may jeopardize the life span of the inverter. · Installation directly exposed under intensive sunlight is not recommended. · The installation site must be well ventilated.

4.2

Pre-installation Check

4.2.1

Check the Package

Although SAJ' s inverters have thoroughly tested and are checked before delivery, it is uncertain that the inverters may suffer damages during transportation. Please check the package for any obvious signs of damage, and if such evidence is present, do not open the package and contact your dealer as soon as possible.

4.2.2

Scope of Delivery

Please refer to the packing list inside the package container.

4.3

The Determination of the Installation Method and Position

4.3.1

Mounting methods

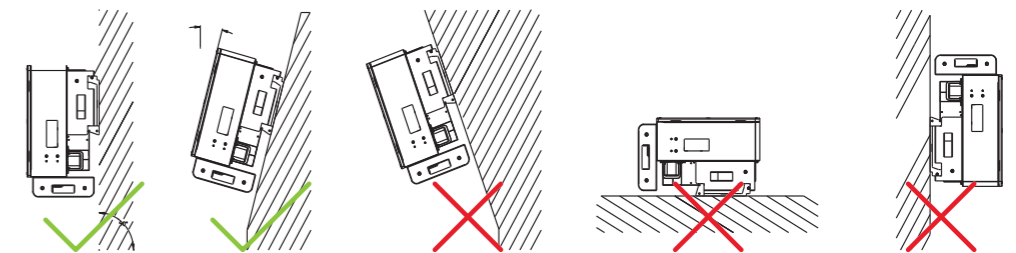
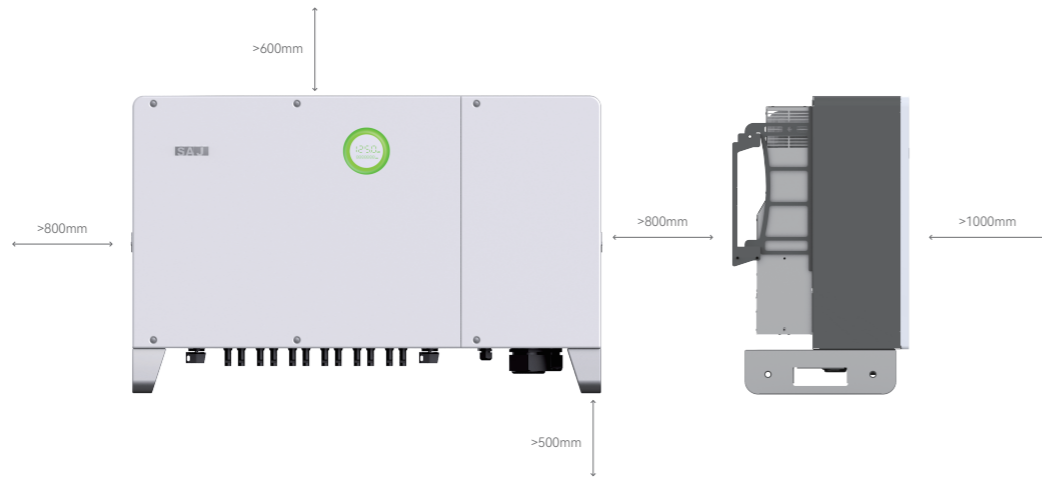

Fig 4.1
Mounting methods

- ① The equipment employs natural convection cooling, and it can be installed indoor or outdoor.
- ② Vertical installation on eye level is recommended. Mount vertically or tilted backwards by max. 15 ° . Never install the inverter tilted forwards, sideways, horizontally or upside down.
- ③ Considering convenience for maintenance, please install the equipment at eye level.
- ④ When mounting the inverter, please consider the solidity of wall for inverter, including accessories, make sure the wall has enough strength to hold the screws and bear the weight of products. Please ensure the mounting bracket mounted tightly.

DO NOT expose the inverter to direct solar irradiation as this could cause power derating due to overheating.
 The ambient temperature should be between $-40^{\circ}\text{C} \sim +60^{\circ}\text{C}$ ($-40^{\circ}\text{F} \sim 140^{\circ}\text{F}$) to ensure optimum operation.
 Choose locations with sufficient air exchange. Ensure additional ventilation, when necessary.
 DO NOT install the inverter near any inflammable and explosive items.

Fig 4.2
Installation clearance



4.4 Mounting Procedure

4.4.1 Wall Mounting

Fig 4.3
Dimensions of mounting bracket
(Dimensions in mm)

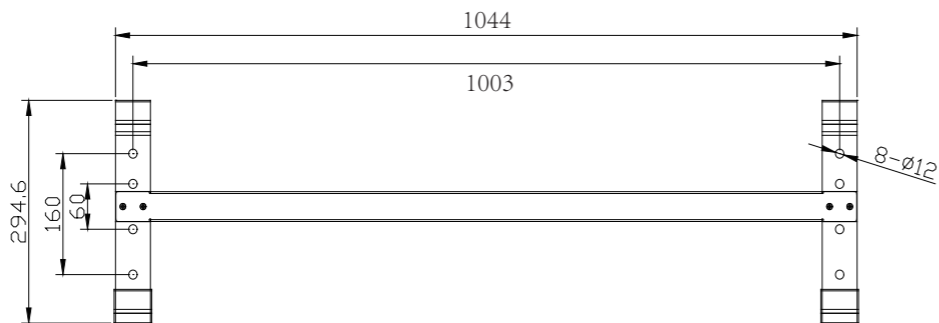

Mark the Positions of the Drill Holes of the Mounting Bracket
 The mounting position should be marked as below.

Fig 4.4
mounting panel drill holes' position

Drill Holes and Place the Expansion Tubes

Follow the given guides, drill 3 holes in the wall (in conformity with position marked in Figure 4.4), and then place expansion tubes in the holes using a rubber mallet.

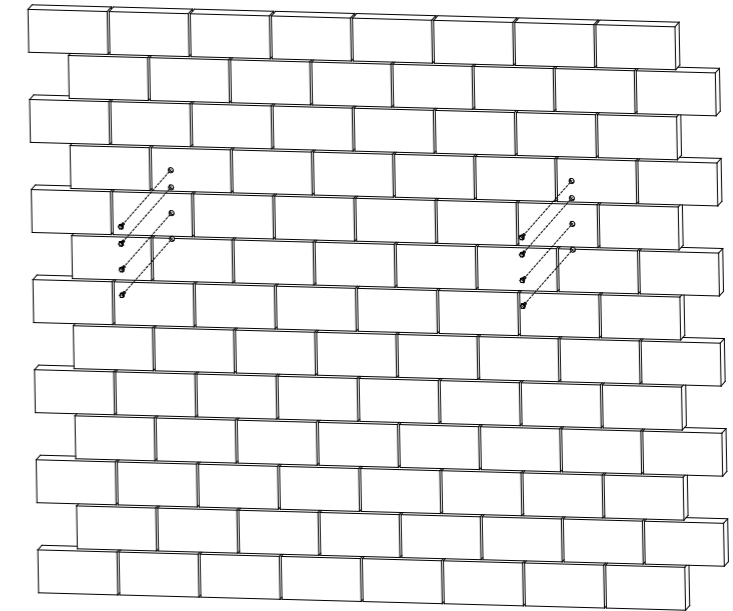

Mount the Screws and the Mounting Bracket

The brackets should be mounted in the mounting position by screws as below.

Fig 4.5
Mount the mounting bracket

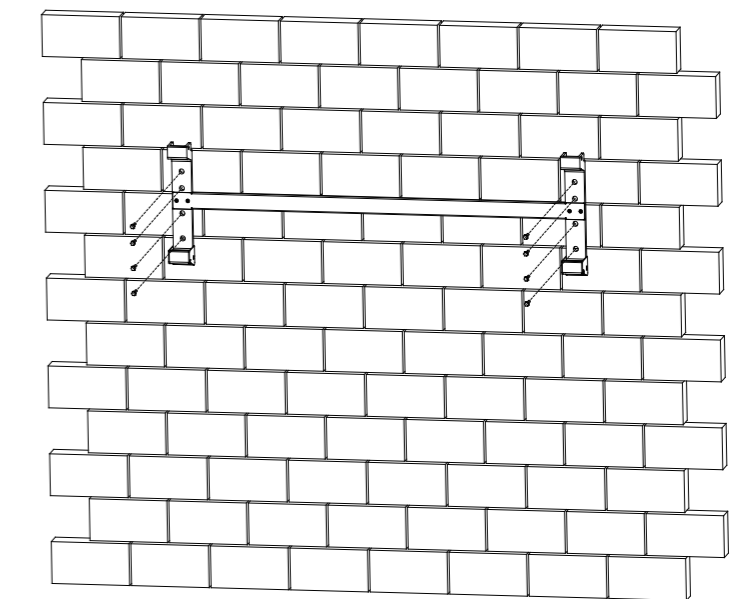

Mount the Inverter

Carefully mount the inverter to the mounting bracket. Make sure that the rear part of the equipment is closely mounted to the mounting bracket.

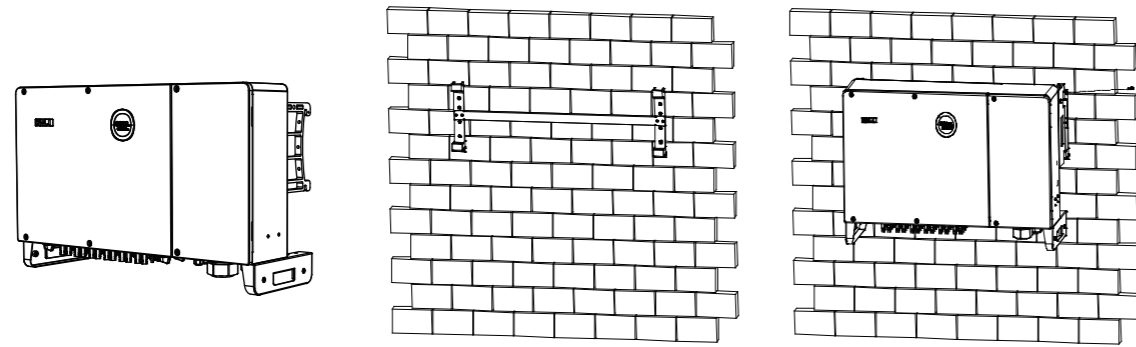

Fig 4.6
Mounting inverter

Mount the Screws and the Mounting Bracket

The brackets should be mounted in the mounting position by screws as below.

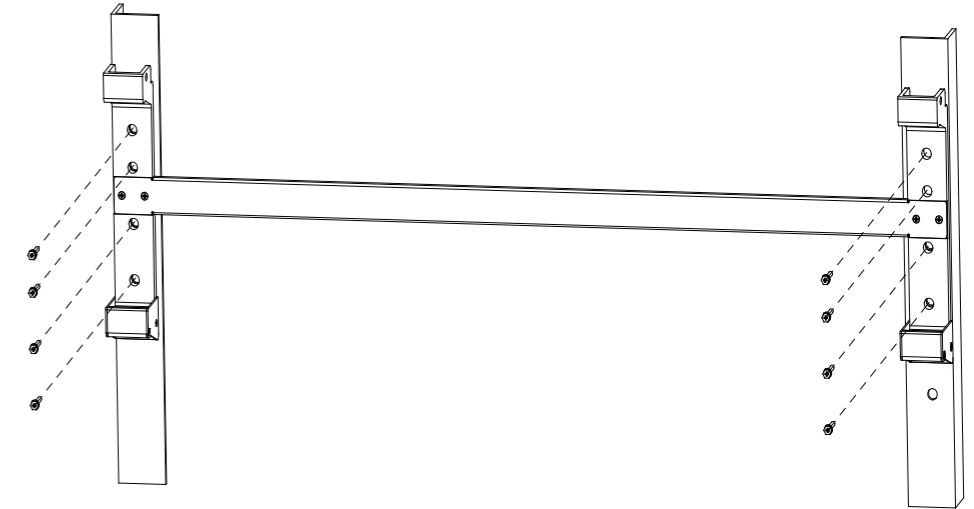

Fig 4.9
Mount the mounting bracket

4.4.2

Bracket Installation

Mark the Positions of the Drill Holes of the Mounting Bracket

The mounting position should be marked as below.

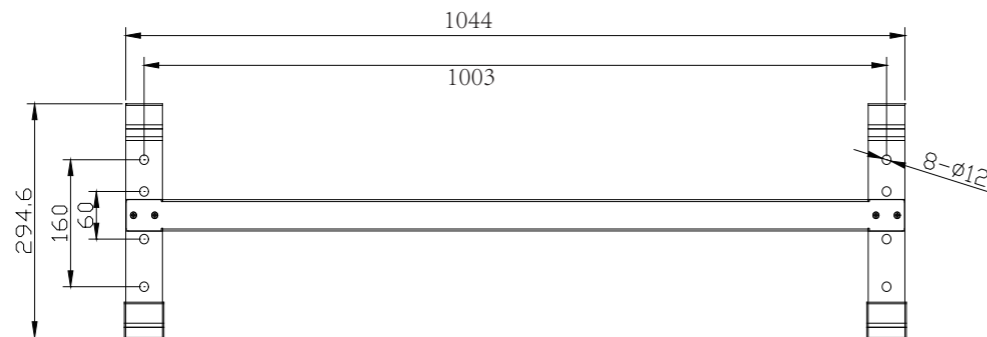

Fig 4.7
Dimensions of mounting bracket
(Dimensions in mm)

Mount the Inverter

Carefully mount the inverter to the mounting bracket. Make sure that the rear part of the equipment is closely mounted to the mounting bracket.

Drill Holes and Place the Expansion Tubes

Follow the given guides, drill 3 holes in the wall (in conformity with position marked in Figure 4.4), and then place expansion tubes in the holes using a rubber mallet.

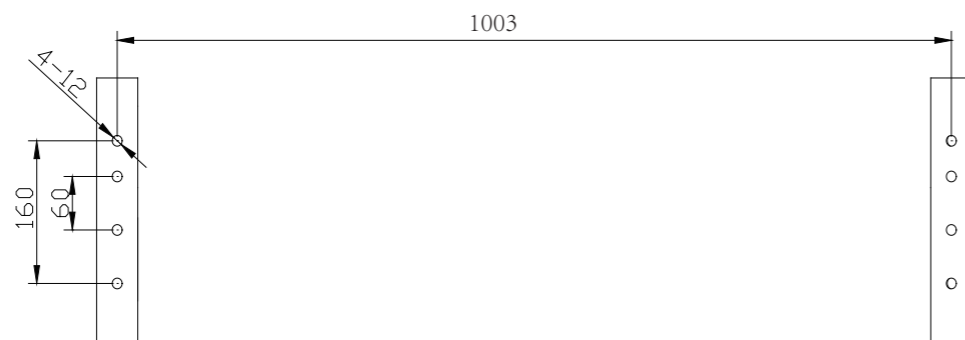
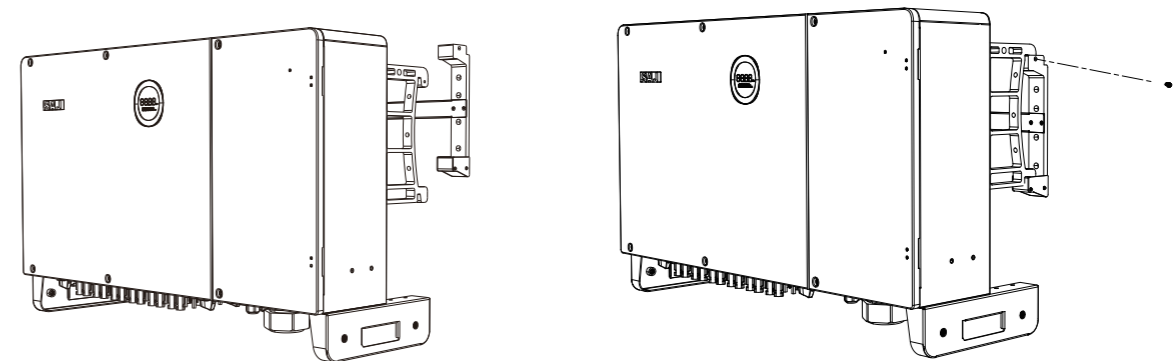
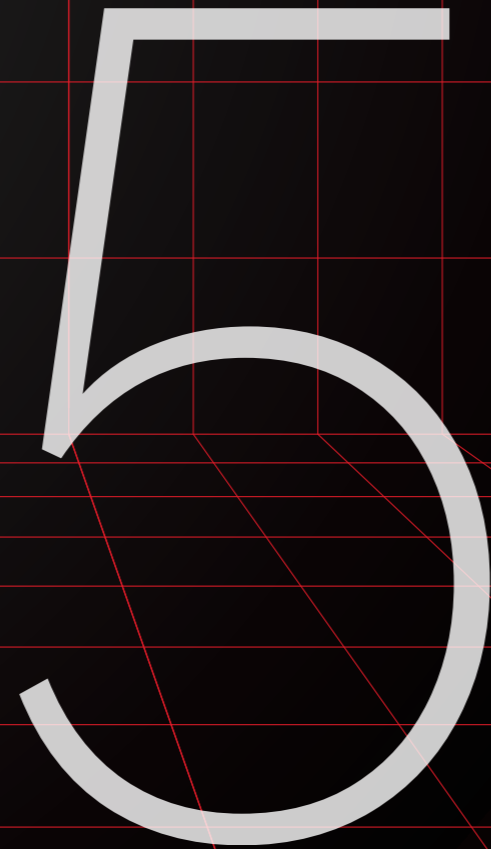

Fig 4.8
Drill holes' dimensions (dimensions in mm)

Fig 4.10
Mounting inverter



Electrical Connection



5.1 Safety Instruction

Electrical connection must only be operated on by professional technicians. Please keep in mind that the inverter is a bi-power supply equipment. Before connection, necessary protective equipment must be employed by technicians, including insulating gloves, insulating shoes and safety helmet.

⚠ DANGER

Dangerous to life due to potential fire or electricity shock.

- The PV panel string will produce lethal high voltage when exposed to sunlight.
- Disconnect DC and AC circuit breakers before starting electrical connections.
- Ensure all the cables have no voltage before conducting cable connection

⚠ WARNING

- Any improper operations during cable connection can cause device damage or personal injury.
- All cables must be undamaged, firmly attached, properly insulated and adequately dimensioned.

⚠ NOTICE

- When power-on, the equipment should be in conformity with national rules and regulations.
- The direct connection between the inverter and high voltage power systems must be operated by qualified technicians in accordance with local and national power grid standards and regulations.

5.2 Specification for Electrical Interface

Figure 5.1
Electrical terminals

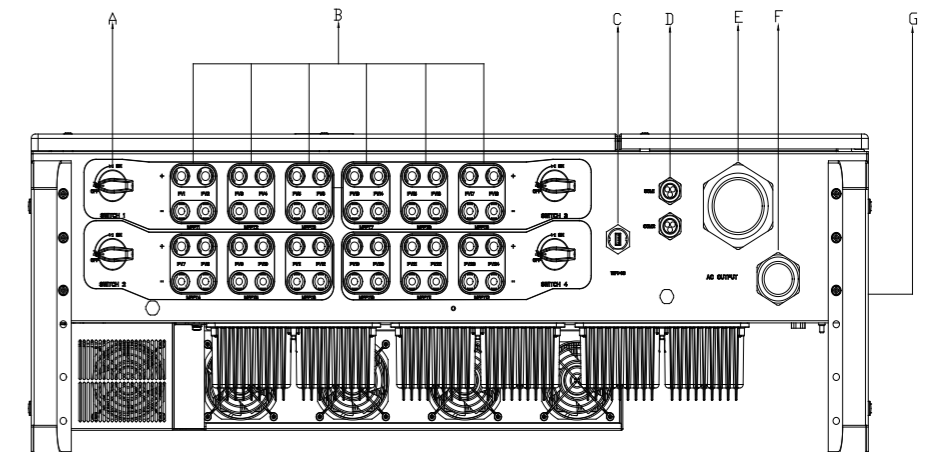

Table 5.1
Specifications for interface

Item	Name
A	DC Switch
B	DC Input
C	RS232 Communication
D	RS485 Communication
E	AC Output
F	Ground Connection
G	Ground Connection

5.3 AC Connection

5.3.1 Electrical Connection Overview

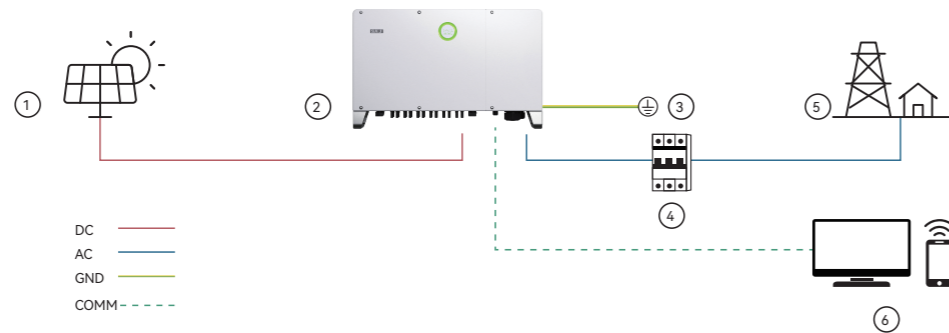

Fig 5.2 Electrical connection overview

Item	Name
1	PV Array
2	C6 Inverter
3	Inverter enclosure grounding connection
4	Circuit Breaker
5	Grid
6	Monitoring Platform

Table 5.2 Electrical connection overview

5.3.2 Cable Specification

Cross-sectional area of cables(mm ²)			External diameter (mm)
Cable type	Scope (S)	Recommended grounding cable (Spe)	
Three core, four core five core cable	95-240	Spe≥S/2	38-66
Four single core cable			14-32

Table 5.3 Recommended power grid connecting cable specification

5.3.3 Circuit Breaker Specification

Model	Recommended circuit breaker rated voltage	Recommended circuit breakerrated current
C6-75K-T6/C6-50K-T6-LV	≥400V	160A
C6-100K-T9/C6-60K-T9-LV		200A
C6-110K-T12/C6-70K-T12-LV		225A
C6-125K-T12		250A

Table 5.4 Recommended circuit breaker specification

5.3.4 OT/OD Terminal Specification

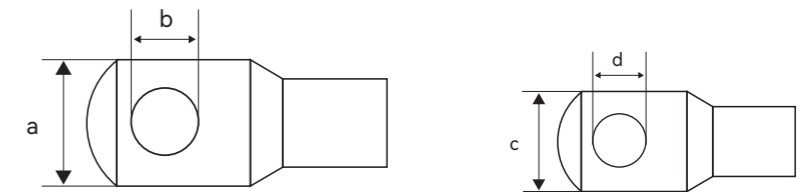

Fig 5.3 OT/OD terminal

L1/L2/L3/N cable terminal Specification:
 PE cable terminal

L1/L2/L3/N cable terminal	M12 size	a≤46mm, 13mm≤b≤15.5mm
PE cable terminal	M8 size	c≤30mm, 8mm≤d≤11mm

Table 5.5 Specification of cables

Note: Do not connect Aluminum OT/OD terminal with AC output terminal, as it will have electrochemical reaction with AC output terminal and affect the reliability of connection. Please choose the OT/OD terminal material according to the cable conductor material as below.

Cable conductor material	Recommended OT/OD terminal material
Copper	Copper
Copper clad aluminum	Copper
Aluminum	Copper to aluminum adapter terminal

Table 5.6 Specification of cable conductor material

5.3.5 Connection of Additional Grounding

⚠ WARNING

- The ground connection of this additional grounding connection cannot replace the AC cable PE terminal connection.
- Make sure that all the grounding points on the enclosures are equipotential connected when there are multiple inverters
- Connect this additional grounding cable before AC cable connection, DC cable connection and communication cable connection.

Note: The additional cable and OT/DT terminal should be prepared by user themselves.

Remove the screw of grounding terminal and secure the additional grounding cable by insert a screw into the screw hole in the OT/DT terminal.

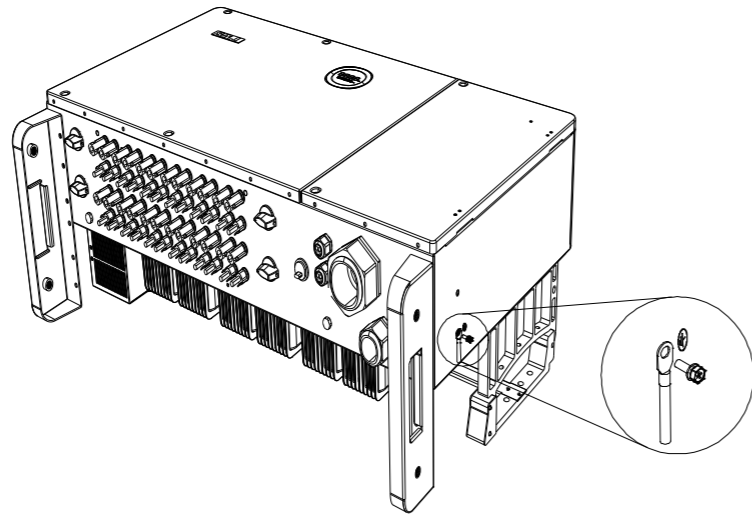

Fig 5.4
Installing additional grounding cable

5.3.6 AC Side Electrical Connection

- 1.Strip off wire insulation skin and AC cable insulation skin to a proper length
- 2.Crimp the AC cable with OT/OD terminal
- 3.Disconnect AC circuit breaker, open the wiring cabinet cover
- 4.Insert the cable through waterproof cable gland and housing
- 5.Insert the conductors into the corresponding ports and fix it with screws
- 6.Secure the cable gland by fastening sealing nut
- 7.Plug the AC connector into the AC connector port of inverter

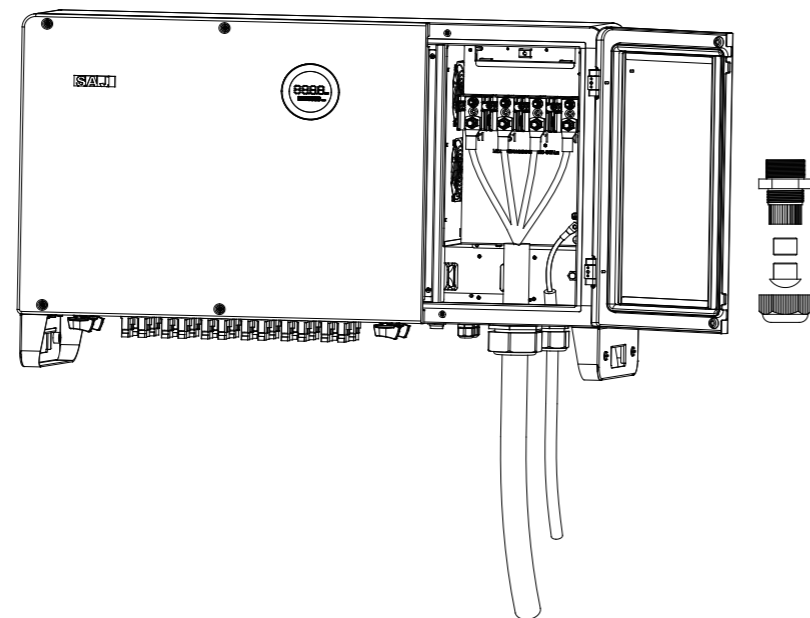

Fig 5.5
AC side electrical connection

5.4 DC Side Electrical Connection

5.4.1 DC cable specification

Table 5.7
Recommended specifications of DC cables

Cross-sectional area of cables(mm ²)	External diameter of the cables(mm)
Scope	6mm-9mm
4≤S≤6	

5.4.2 PV Connector Assembly

⚠ DANGER

Dangerous to life due to electric shock when live components or DC cables are touched.

- The PV panel string will produce lethal high voltage when exposed to sunlight. Touching live DC cables results in death or lethal injuries.
- DO NOT touch non-insulated parts or cables
- Disconnect inverter from voltage sources.
- DO NOT disconnect DC connectors under load.
- Wear suitable personal protective equipment for all work.

⚠ WARNING

- Make sure the PV array is well insulated to ground before connecting it to the inverter.
- Make sure the maximum input voltage of each string is not exceeding 1100V
- When input voltage is between 950V~1100V, the inverter will enter standby mode. When the input voltage returns to MPPT operating voltage range, which is 180V~950V, the inverter will return to normal mode.
- Make sure the maximum short-circuit current of DC side is within the permissible range.

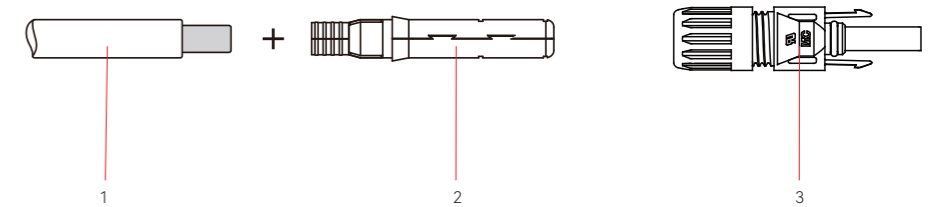

1. Insulated enclosure 2. Lock screw 3. Positive connector

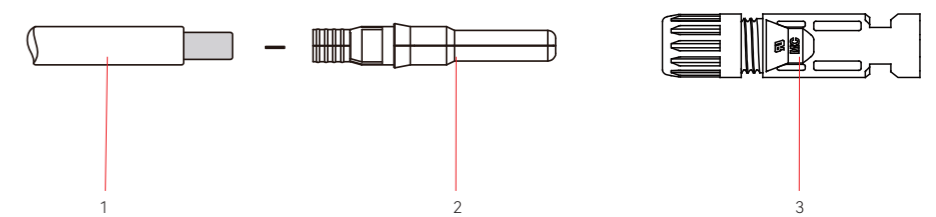

1. Insulated enclosure 2. Lock screw 3. Negative connector

Fig 5.6
Positive connector

Fig 5.7
Negative connector

Connecting Procedures:

1. Tighten the lock screws on positive and negative connector.
2. Strip the insulation of the positive and negative cables with 8-10mm length.

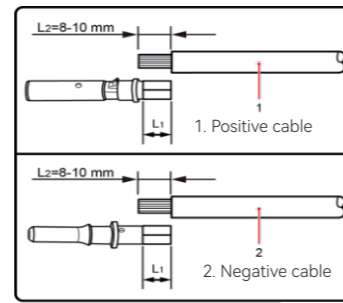

Fig 5.8 Stripping off the insulation skin of cables

3. Feed the positive and negative cables into corresponding lock screws.

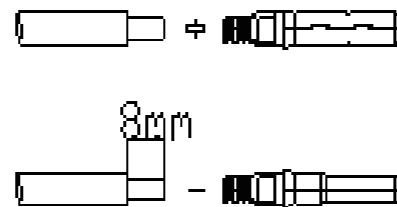

Fig 5.9 Inserting cables to lock screws

4. Insert the positive and negative connectors into positive cable and negative cable whose insulated enclosure has been stripped off, and crimp them tightly with a wire crimper. Make sure that the withdrawal force of the pressed cable is bigger than 400N.

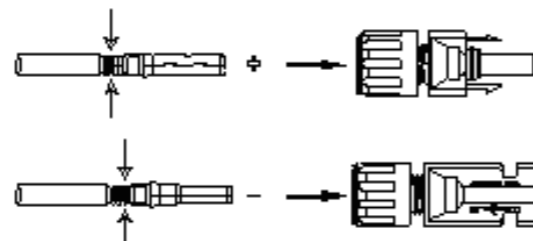

Fig 5.10 Inserting crimped cables to connectors

5. Plug in the pressed positive and negative cables into relevant insulated enclosure, a “click” should be heard or felt when the contact cable assembly is seated correctly.
6. Fasten the lock screws on positive and negative connectors into respective insulated enclosure and make them tight.

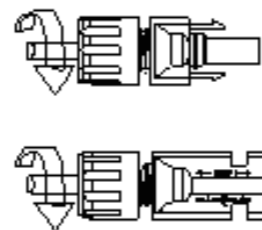

Fig 5.11 Securing the connectors

7. Make sure the DC switch is at OFF position
8. Connect the positive and negative connectors into positive and negative DC input terminals of the inverter, a “click” should be heard or felt when the contact cable assembly is seated correctly.

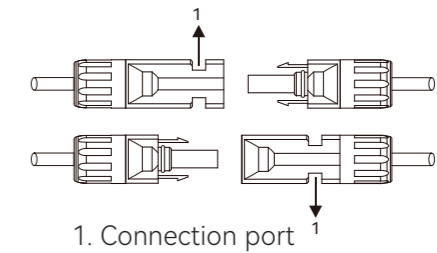

Fig 5.12 Plug in connectors

5.5 Communication Connection

5.5.1 Communication Terminal Overview

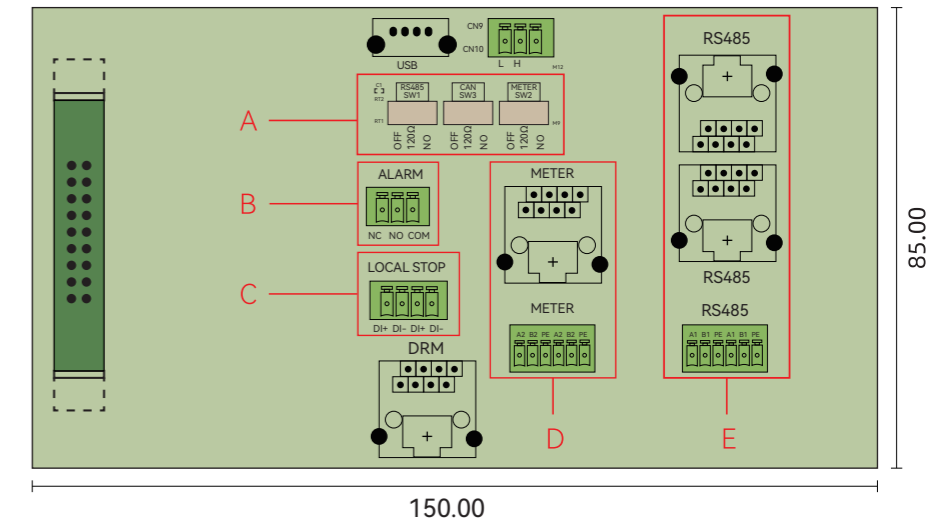

Fig 5.13 Communication terminal overview

Table 5.8 Terminal description

Position	Description
A	DIP Switch
B	Alarm Output Dry Contact
C	Emergency Stop Dry Contact
D	Meter Output
E	RS485 Communication Port

5.5.2 Dry Contact Connection

Fig 5.14 Dry contact overview

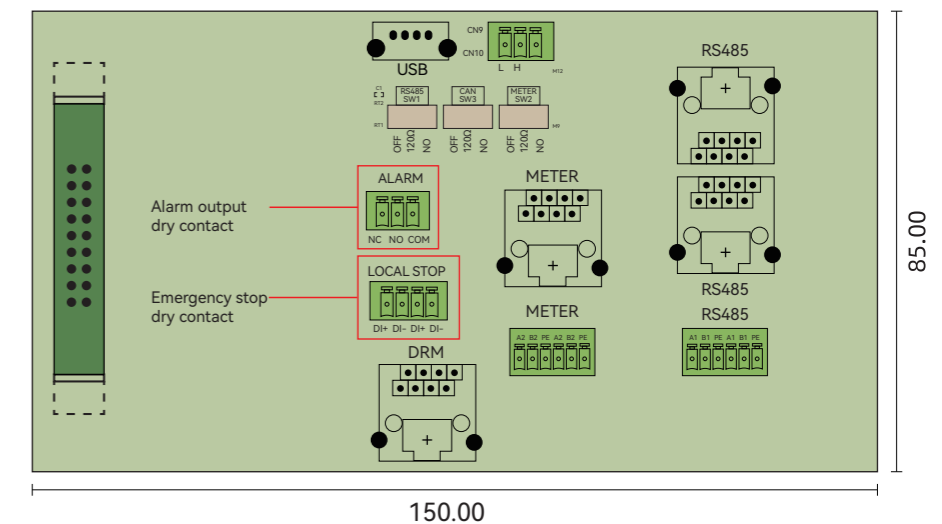

The inverter is integrated with alarm output dry contact and emergency stop dry contact.

Alarm output dry contact:

Relay can be set to normal open contact (COM&NO) or normal close contact (COM&NC), when inverter is in alarm/fault state, the fault status can be indicated by LED indicator or other external display device.

1.LED indicator as the alarm/fault indicator. When relay is in normal close contact (NC) and no alarm/fault occurs, LED indicator is on; When there is fault occurs, relay is in normal open contact (NO), LED indicator is off.

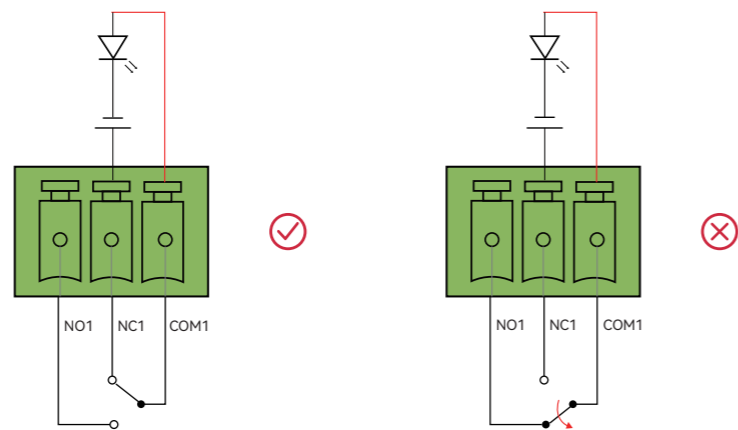

Fig 5.15
Relay is in normal close contact

2.LED indicator as the alarm/fault indicator. When relay is on normal open contact (NO) and no alarm/fault occurs, LED indicator is off; When there is fault occurs, relay is on normal close contact (NC), LED is on.

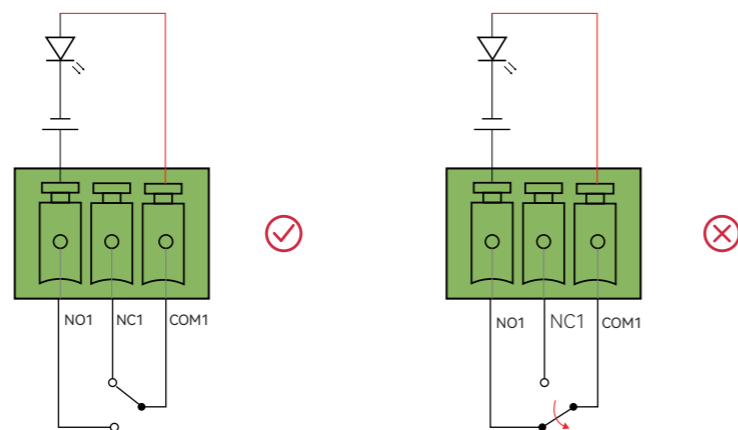

Fig 5.16
Relay is in normal open contact

Emergency stop dry contact:

When DI+ contact and DI- contact are shorted by external controlled switch, the inverter will stop immediately.

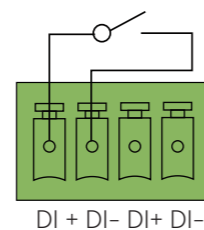

Fig 5.17
Emergency stop dry contact

Multiple inverter dry contact connection

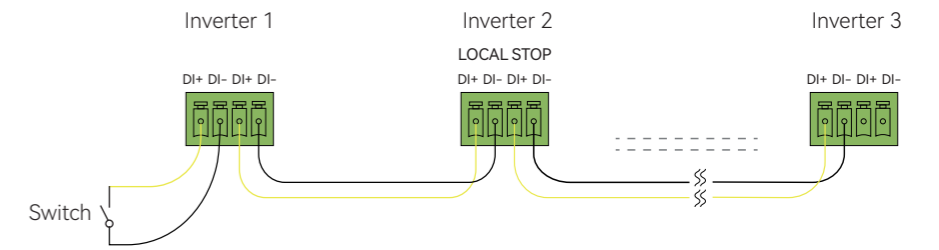

Fig 5.18
Multiple inverter dry contact

5.6 RS485 Communication Connection

The inverter is integrated with RS485 communication terminal and meter communication terminal. RS485 communication terminal is mainly for multiple inverters communication which can be connected in a daisy chain manner. Meter communication terminal is mainly for data interaction between monitoring device and inverter.

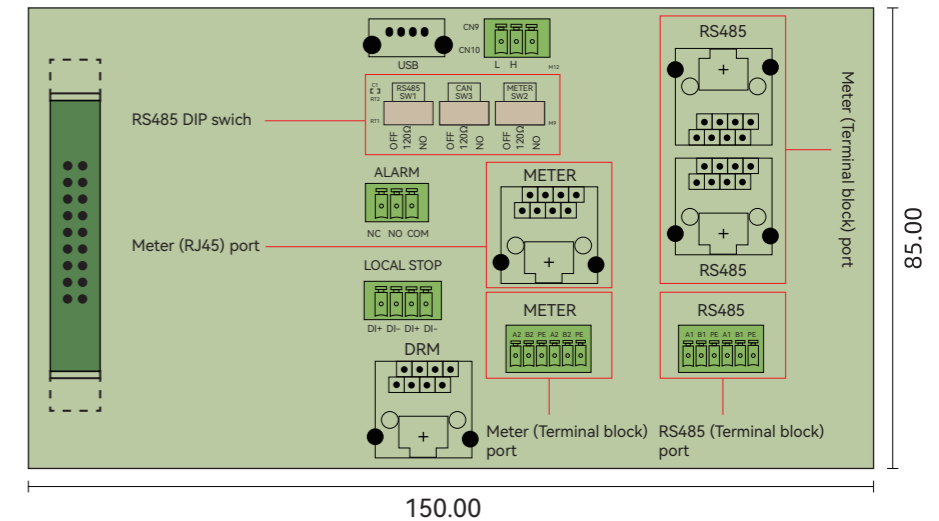

Fig 5.19
RS485 communication

Note: Meter and RS485 communication have two kinds of interface, one is RJ45 terminal, another is terminal block, these two ports perform the same function but with different wiring. Please choose either one interface for cable connection.

Table 5.9
RS485 pin port description

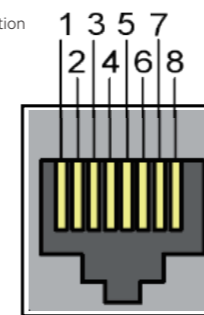

Fig 5.20
RS485 pin

Pin Number	Wire color	Function
1	White-orange	NC
2	Orange	NC
3	White-green	NC
4	Blue	NC
5	White-blue	NC
6	Green	NC
7	White-brown	RS485-A
8	Brown	RS485-B

Terminal block:

Pin	name	Function
A1	RS485-A+	RS485 in, RS485A differential signal +
B1	RS485-B-	RS485 in, RS485B differential signal -
PE	PE	GND, shielded earthing point
A1	RS485-A+	RS485 in, RS485A differential signal +
B1	RS485-B-	RS485 in, RS485B differential signal -
PE	PE	GND, shielded earthing point

Table 5.10
Terminal block description

Fig 5.21
RS485 terminal block

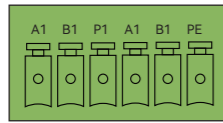

Note: When there are multiple inverters connected, please connect a terminating resistor between A1 and B1 by switching the RS485 DIP switch, to ensure the communication quality.

Single inverter terminal block connection:

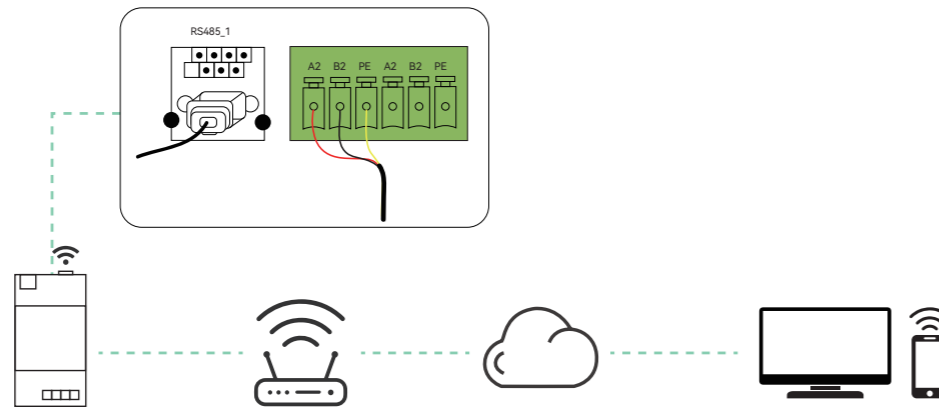

Fig 5.22
Single inverter terminal block

Multiple inverter terminal block connection:

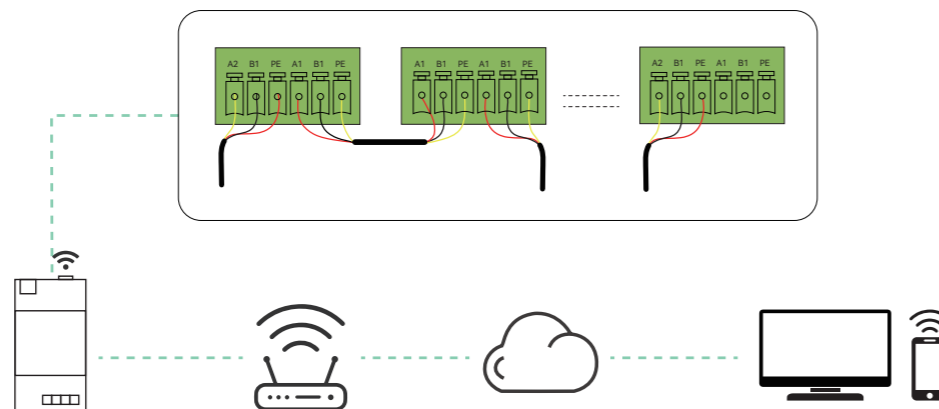

Fig 5.23
Multiple inverter terminal block

5.7 RS232/USB Connection

Figure 5.24
RS232 pin

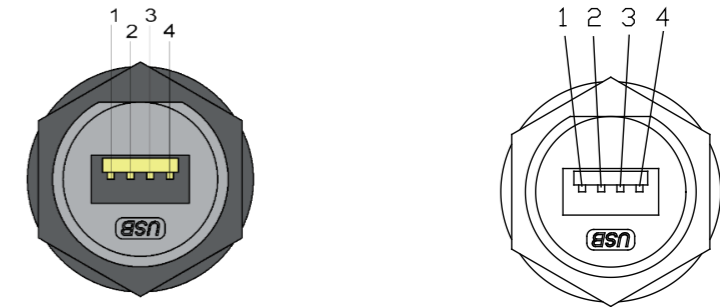
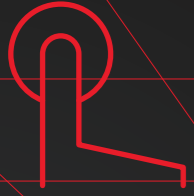

Table 5.11
USB pin port definition

Pin Number	Description	Function
1	+5V	Power supply
2	RS-232 TX	Send data
3	RS-232 RX	Receive data
4	GND	Ground wire

USB interface could be externally connected with eSolar WiFi /4G/AIO3 communication module, for operation in details please refer to communication module Quick Installation Guide in <https://www.saj-electric.com/>.



Introduction of Human-computer Interface

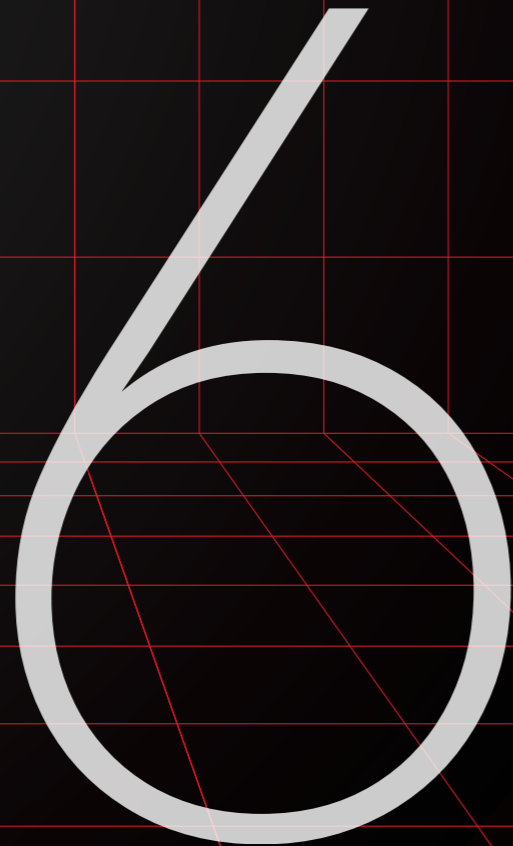

6.1

Introduction of Human-computer Interface

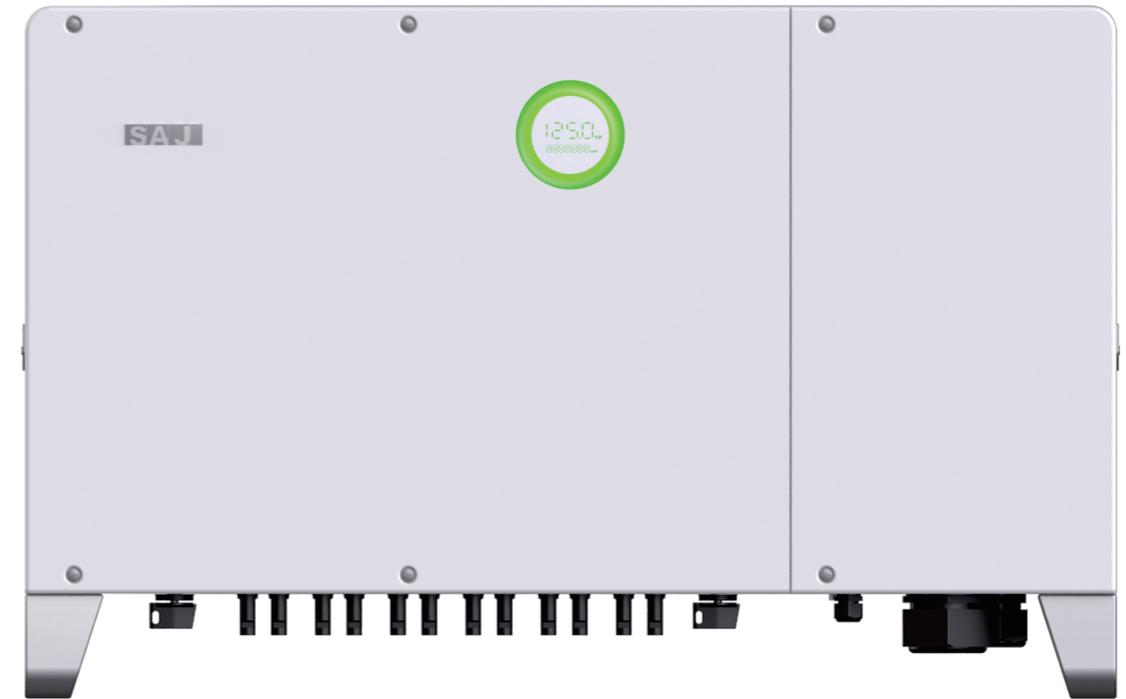

Fig 6.1
Human-computer interface

Display	Status		Description
Ring Light	◉	Solid Green	The inverter is in normal on-grid state
		Breathing Mode	The inverter is in initialization or waiting state
	◉	Solid Red	An error occurs
		Breathing Mode	Software is upgrading in the inverter
	○	Off	Power off
LED Panel 1	8888 kw / 10.315		Current power(kW)/ Error code
LED Panel 2	8888888 kWh		Total yield (kWh)

Table 6.1 Interface description

6.2 Installer APP Installation

eSAJ Home could achieve communication with the equipment via Bluetooth ,Ether-net ,Cellular network and Wi-Fi and it is an APP for nearby and remote monitoring.
 Download eSAJ Home APP
 iOS system: search for “eSAJ Home” in App Store and download this App.
 Android system: search for “eSAJ Home” in Google play and download this App.
 Account---Please use the installer account to login.

6.2.1 Nearby Monitoring

Connection setting

- Step 1: Log in to eSAJ Home, if you do not have an account, please register first.
- Step 2: Go to the “Tool” interface and select “Remote Configuration”
- Step 3: Click on “Bluetooth” and activate the Bluetooth function on your phone, then click on “NEXT STEP”
- Step 4: Choose your inverter according to your inverter SN’s tail numbers

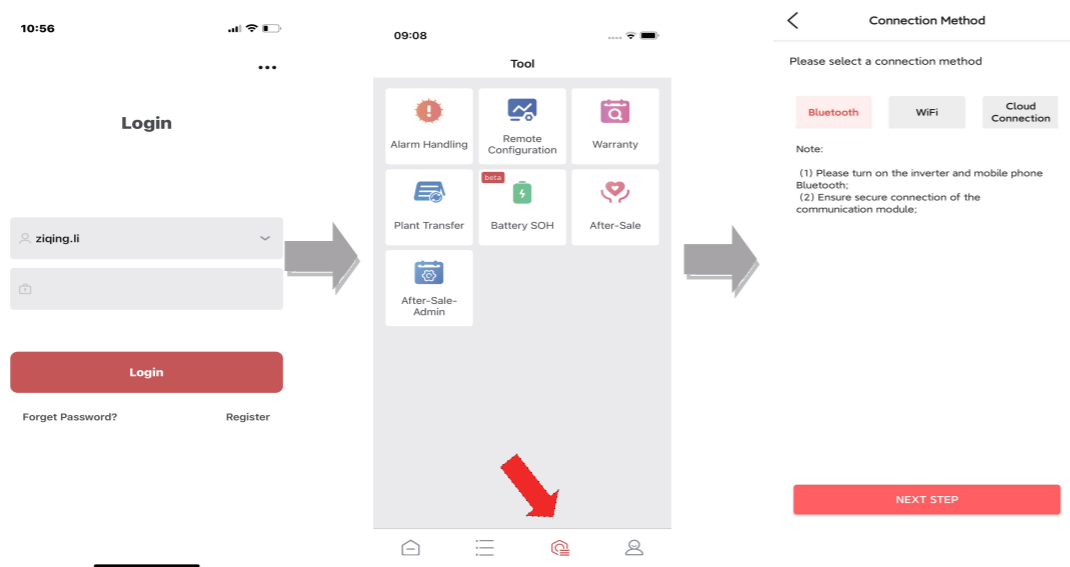

6.2.2 Initial Set Up

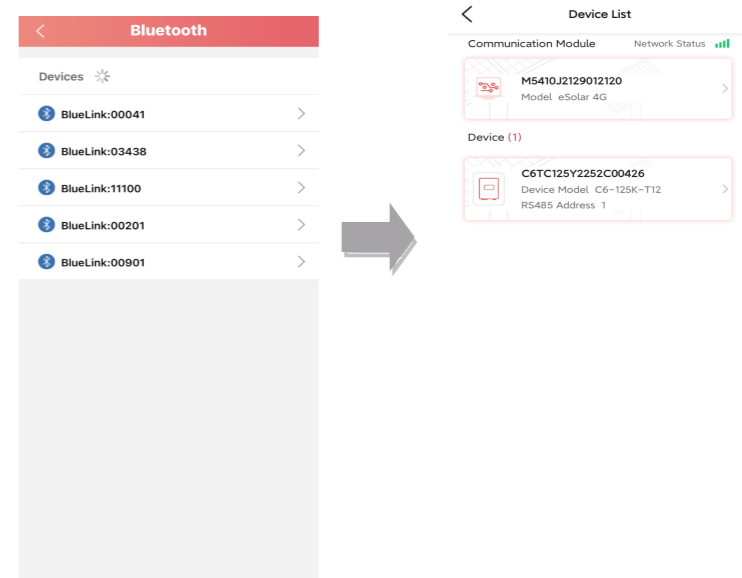

Select the initial setting. Choose your corresponding country/region and grid compliance, please contact your local grid operator for which grid compliance to select. Set the inverter time based on your location.

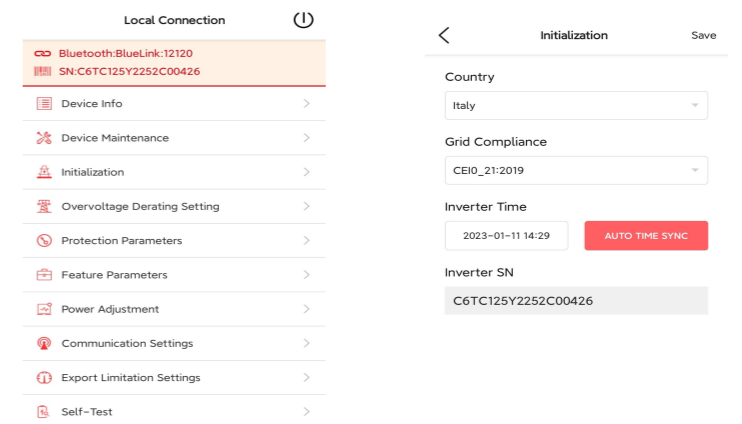

Fault Code and Troubleshooting

7.1

Fault Code

Code	Fault Information
1	Master Relay Error
2	Master EEPROM Error
3	Master Temperature High Error
4	Master Temperature Low Error
5	Lost Communication M<->S
6	GFCI Device Error
7	DCI Device Error
8	Current Sensor Error
9	Master Phase1 Voltage High
10	Master Phase1 Voltage Low
11	Master Phase2 Voltage High
12	Master Phase2 Voltage Low
13	Master Phase3 Voltage High
14	Master Phase3 Voltage Low
15	Grid Voltage 10Min High
18	Master Grid Frequency High
19	Master Grid Frequency Low
21	Phase1 DCV High
22	Phase2 DCV High
23	Phase3 DCV High
24	Master No Grid Error
27	GFCI Error
28	Phase1 DCI High
29	Phase2 DCI High
30	Phase3 DCI High
31	ISO Error
32	Bus Voltage Imbalance
33	Master Bus Voltage High
34	Master Bus Voltage Low
35	Master Grid Phase Error
36	Master PV Voltage High
37	Master Islanding Error
38	Master HW Bus Voltage High
39	Master HW PV Current High
40	Master Self-Test Failed
41	Master HW Inv Current High

Code	Fault Information
42	Master AC SPD Error
43	Master DC SPD Error
44	Master Grid NE Voltage Error
45	Master Fan1 Error
46	Master Fan2 Error
47	Master Fan3 Error
48	Master Fan4 Error
49	Lost Communication between Master and Meter
50	Lost Communication between M<->S
51	Lost Communication between inverter and SEC
52	HMI EEPROM Error
53	HMI RTC Error
56	CT Device Err
57	AFCI Lost Com.Err
58	Lost Com. H<->S Err
61	Slave Phase1 Voltage High
62	Slave Phase1 Voltage Low
63	Slave Phase2 Voltage High
64	Slave Phase2 Voltage Low
65	Slave Phase3 Voltage High
66	Slave Phase3 Voltage Low
67	Slave Frequency High
68	Slave Frequency Low
73	Slave No Grid Error
74	Slave PV Input Mode Error
75	Slave HW PV Curr High
76	Slave PV Voltage High
77	Slave HW Bus Volt High
81	Lost Communication D<->C
83	Master Arc Device Error
84	Master PV Mode Error
85	Authority expires
86	DRM0 Error
87	Master Arc Error
88	Master SW PV Current High

7.2

Troubleshooting

Error info	Troubleshooting
Relay Error	If this error occurs frequently, please contact your distributor or call SAJ technical support.
Storage Error	If this error occurs frequently, please contact your distributor or call SAJ technical support.
High Temperature Error	Check whether the radiator is blocked, whether the inverter is in too high or too low temperature, if the above mentioned is in normal, please contact your distributor or call SAJ technical support.
GFCI Device Error	If this error occurs frequently, please contact your distributor or call SAJ technical support.
DCI Device Error	If this error occurs frequently, please contact your distributor or call SAJ technical support.
GFCI Devices Error	If this error occurs frequently, please contact your distributor or call SAJ technical support.
DCI Devices Error Master	If this error occurs frequently, please contact your distributor or call SAJ technical support.
DCI Devices Error Master	If this error occurs frequently, please contact your distributor or call SAJ technical support.
AC Voltage Error	<ul style="list-style-type: none"> · Check the volt. of the grid · Check the connection between the inverter and the grid. · Check the settings of the on-grid standards of the inverter. · If the volt. of the grid is higher than the volt. regulated by local grid, please inquire the local grid workers whether they can adjust the volt. at the feed point or change the value of the regulated volt. · If the volt. of the grid is in regulated range as allowed and LCD still in this error, please contact your distributor or call SAJ technical support.
Frequency Error	Check the setting of country and check the frequency of the local grid. If the above mentioned are in normal, please contact your distributor or call SAJ technical support.

Error info	Troubleshooting
Grid Lost Error	Check the connection status between the AC side of the inverter and the grid, if the above mentioned are in normal, please contact your distributor or call SAJ technical support.
GFCI Error	Check the insulation resistance of the positive side and negative side of the solar panel; check whether the inverter is in wet environment; check the grounding of the inverter. If the above mentioned are in normal, please contact your distributor or call SAJ technical support.
DCI Error	If this error exists always, please contact your distributor or call SAJ technical support.
ISO Error	Check the insulation resistance of the positive side and negative side of the solar panel; check whether the inverter is in wet environment; check whether the grounding of the inverter is loose or not. If the above mentioned are in normal, please contact your distributor or call SAJ technical support.
Overcurrent	Check the connection status between the inverter and the grid and test whether the volt. of the grid is stable or not, if the above mentioned are in normal, please contact your distributor or call SAJ technical support.
Over Bus Voltage	Check the settings of the solar panel. SAJ designer can help you. If the above mentioned are in normal, please contact your distributor or call SAJ technical support.
PV Overcurrent	If this error always exists, please contact your distributor or call SAJ technical support.
PV Voltage Fault	Check the settings of the solar panel. SAJ designer can help you. If the above mentioned are in normal, please contact your distributor or call SAJ technical support.
Lost Communication	Check the connection of communication cables between control board and display board. If the above mentioned are in normal, please contact your distributor or call SAJ technical support.
Null line-to-earth voltage fault	Check if connection of the AC output grounding terminal is stable and reliable. If the content mentioned as above is normal, please contact your distributor or call SAJ technical support.



Routine Maintenance



8.1

Routine Maintenance

Inverter Cleaning

Clean the enclosure lid and LED indicator of the inverter with moistened cloth with clear water only. Do not use any cleaning agents as it may damage the components.

Heat Sink Cleaning

Clean the heat sinks with dry cloth or air blower. Do not clean the heat sink with water or cleaning agents. Make sure there is enough space for ventilation of inverter.

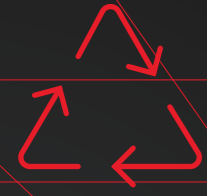

Recycling and Disposal

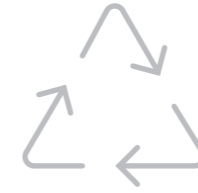

This device should not be disposed as residential waste. An inverter that has reached the end of its life and is not required to be returned to your dealer it must be disposed carefully by an approved collection and recycling facility in your area