



W-HHT-5000/6000/8000/10000/12000 Series

ENG-W-HHT_3_12K_USERMANUAL

USER MANUAL

V1.02

CONTENTS

1. INTRODUCTION	4
1.1 Operation modes introduction Modalità di Funzionamento	4
1.2 Symbols on the label	4
2. SAFETY AND WARNINGS	5
3. UNPACKING	7
3.1 Scope of Delivery	7
3.2 Product Overview The total size of W-HHT-5000/6000/8000/10000/12000 is 425(width) ×351(height) ×200(depth) mm. It has 2 pairs of PV input terminals, 1 pair of Battery input terminal and 2 communication ports. It also has a LED&LCD (or just LED, determined by user) for getting information and setting parameters at field.	7
4. INSTALLING	9
4.1 Installation Requirement	9
4.2 Mounting Location	10
4.3 Mounting	10
4.4 Installing the PE cable	11
5. COMMISSIONING	12
5.1 Safety Instructions	12
5.2 AC Wire Assembly and Connection	13
5.3 Back-up Wire Assembly and Connection	13
5.4 PV Wire Assembly and Connection	14
5.5 Battery Wire Assembly and Connection	15
5.6 Residual Current Protection	15
6. COMMUNICATION	16
6.1 System monitoring via Wi-Fi Stick - RS485/Wi-Fi /GPRS	16
6.2 Auto Test (ONLY for Italian Market)	17
7. START UP AND OPERATION	18
7.1 Safety Check Before Start Up	18
7.2 Inverter LED Indicators	19
7.3 Display and Control Logics	20
8. DISCONNECTING FROM VOLTAGE RESOURCES	21
9. TECHNICAL PARAMETERS	22
10. TROUBLE SHOOTING	24

11.	SYSTEM MAINTENANCE	28
12.	RESTARTS.....	29
13.	LEGAL WARRANTIES.....	29
14.	WASTE DISPOSAL	30

1. INTRODUCTION

1.1 Operation modes introduction Modalità di Funzionamento

W-HHT normally has the following operation modes based on your configuration and layout conditions.

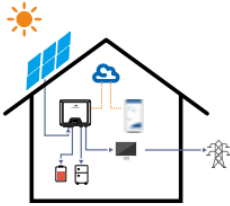

Mode I

The energy produced by PV is used to charge the battery, then exported to grid.

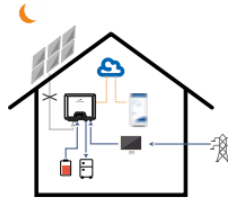

Mode II

When there is no PV, and the battery is sufficient, It can supply the load with the grid together.

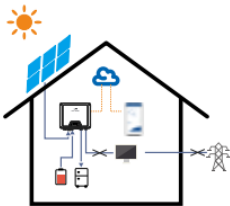

Mode III

When grid fails, the system automatically switches to Back-Up mode, the Back-Up load could be supported by PV and battery.

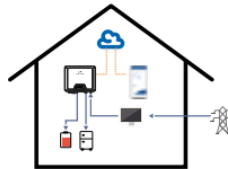







Mode IV

Battery could be charge by grid, and charge time/power could be set flexibly on my Leonardo App and web platform

1.2 Symbols on the label

	DANGER, WARNING AND CAUTION		RECYCLABLE AND REUSABLE
	HIGH VOLTAGE AVOID CONTACT		AVOID DAMP AND MOISTURE
	HIGH TEMPERATURE AVOID CONTACT		SHIPMENT STACK LIMIT: 7

	CE MARKS		DO NOT DISPOSE WITH HOUSEHOLD WASTE
	PROCEED OPERATIONS AFTER 5 MINUTES DISCHARGE		BREAKABLE ITEM
	PLACE UPWARDS		USER MANUAL IN PACK

2. SAFETY AND WARNINGS

1. All persons who are responsible for mounting, installation, commissioning, maintenance, tests, and service of WESTERN CO inverter products must be suitably trained and qualified for corresponding operations. They MUST be experienced and have knowledge of operation safety and professional methods. All installation personnel must have knowledge of all applicable safety information, standards, directives, and regulations.
2. The product must ONLY be connected and operated with PV arrays of protection class II, in accordance with IEC 61730, application class A. The PV modules must also be compatible with this product. Power resources other than compatible PV arrays MUST not be connected and operate with the product.
3. When designing or constructing a PV system, all components MUST remain in their permitted operating ranges, and their installation requirements MUST always be fulfilled.
4. Under exposure to sunlight, the PV array may generate dangerous output in DC voltage. Contacts with the DC wires, conductors and live components in the inverter may result in lethal shocks.
5. High voltages in inverter could cause lethal electrical shocks. Before proceeding any work, including maintenance and/or service, on the inverter, fully disconnect it from all DC input, AC grid and other voltage sources. There MUST be a 5-minute waiting time after the full disconnection.













6. The DC input voltage of the PV array MUST never exceed the maximum input voltage of the inverter.
7. DO NOT touch parts of the inverter during operation as heat will be induced and these parts will exceed 60°C.
8. There are installations where multiple inverter energy systems are used and electrical installation connects at 3-phase points of supply to the grid, please refer to the requirements of Appendix B.
9. Safe Transport / Handling:
 - Find the mark of PLACE UPWARDS on the inverter container and keep it upward.
 - The inverter container should be tied or fixed during transportation.
 - The transport of the inverter requires two people for lifting, there is one handle on the left and one on the right.
 - The inverter should be protected from heavy vibrations and shocks during transportation.
10. Compatible Battery Models

Brand	Model
Pylontech	Force-H1
	Force-H2
	Powercube X1
	Powercube X2
	Powercube H1
	Powercube H2
Dyness	Tower T7/T10/T14/T17/T21
Soluna	HV PACK 10K & 15K

3. UNPACKING

3.1 Scope of Delivery

Please inspect and check for completeness in the scope of delivery. Confirm with purchase order.

												
Inverter	Mounting Bracket	Mounting Accessories	Devalan DC Plugs (Sealed)	Bat +/- Connector	BACK-UP Connector	AC-GRID Connector	W-Hi Manager Plug	Meter/Dred Connector	Communication Datalogger	CT	Rj45 Adapter	Documents
1	1	1	2	1	1	1	1	1	1	3	1	1

3.2 Product Overview

The total size of W-HHT-5000/6000/8000/10000/12000 is 425(width) ×351(height) ×200(depth) mm. It has 2 pairs of PV input terminals, 1 pair of Battery input terminal and 2 communication ports. It also has a LED&LCD (or just LED, determined by user) for getting information and setting parameters at field.

The detail description is shown below:

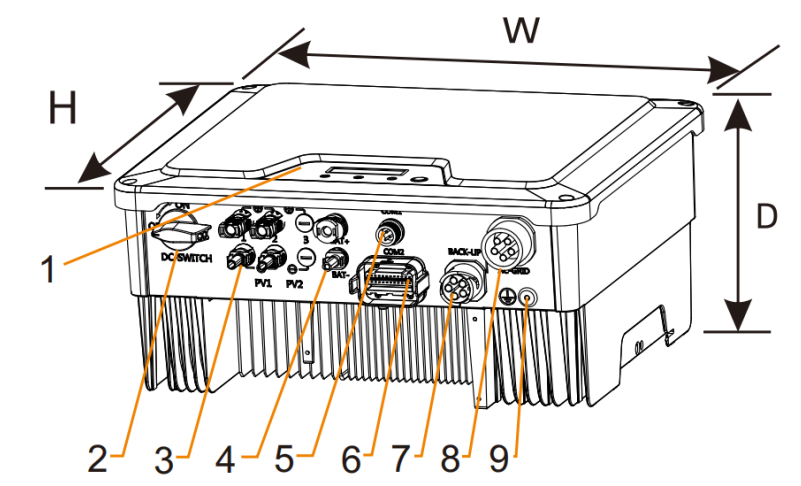

Mark Num.	Component	Description
1	LED&LCD or LED	Display and setting device at field
2	DC Switch	For switch on/off the inverter
3	PV Terminal (s)	Connected with PV Panel
4	Battery Terminal	Connected with Battery
5	COM1: Wi-Fi/4G	Alternative Wireless communication
6	COM2: BMS/CT/Meter/DRED/RS485	For CT,Meter,BMS,DRED,RS485
7	Back-up Terminal	Connected with Back-up for EPS
8	AC Terminal	Connected with AC Grid
9	Secondary PE Terminal	For Grounding Protection

4. INSTALLING

4.1 Installation Requirement

1. Please install the inverter(s) in places that can avoid inadvertent contact.
2. Installation method, location and surface must be fitting for the inverter's weight and dimensions.
3. Please install the inverter in an accessible location for operation, future maintenance and service.
4. The inverter performance peaks at ambient temperature lower than 45°C.
5. When installing in residential or domestic environment, it is recommended to install and mount the inverter on a solid, concrete wall surface. Mounting the inverter on composite or plaster boards or walls with similar materials would induce noise during its operation and is therefore not recommended.
6. DO NOT cover the inverter NOR place any objects on top of the inverter.
7. To ensure sufficient room for heat dissipation and maintenance, the clearing space between inverter(s) and other surroundings is indicated below for reference:

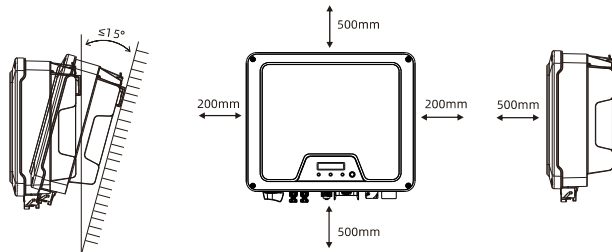

8. Avoid direct exposure to sunlight and rain and snow layup.

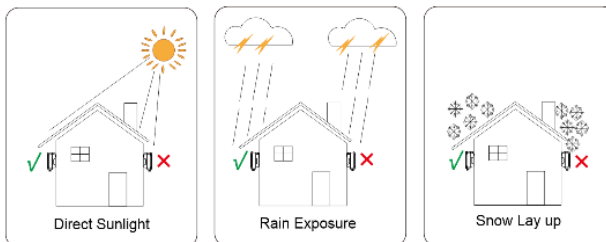

4.2 Mounting Location

1. DO NOT mount the inverter near any inflammable materials.
2. DO NOT mount the inverter near any explosive materials.

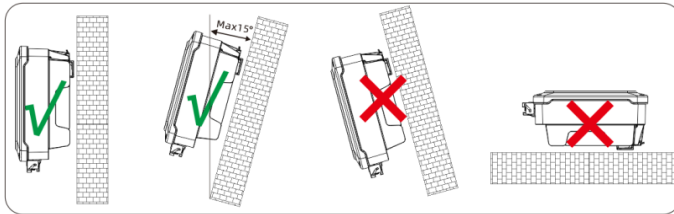

3. DO NOT mount the inverter on tilting surface over 15° backwards. Please mount the inverter on a vertical wall surface.
4. DO NOT mount the inverter on any surfaces tilting forward or to either sides.
5. DO NOT mount the inverter on a horizontal surface.
6. For easy installation and operation, please mount the inverter on a height that the display could match eye level.
7. The bottom side where all commissioning terminals are equipped MUST always point downwards.

4.3 Mounting

1. Use the mounting bracket as a template and drill holes of 10mm diameter and 70mm depth.
2. Fix the mounting bracket with the screws and expansion bolts packed in mounting accessories.
3. Hold up the inverter and tilt it slightly forward. Hang up the inverter and attach it to the mounting bracket. Check both sides of the heat sink to ensure its stably attached.
4. Use M5 screws (T25 screwdriver, torque 2.5 Nm) to attach the heat sink fins to the mounting bracket.
5. It is recommended to attach the anti-theft lock to the inverter. Lock diameter $\phi 4-5.5\text{mm}$ recommended.

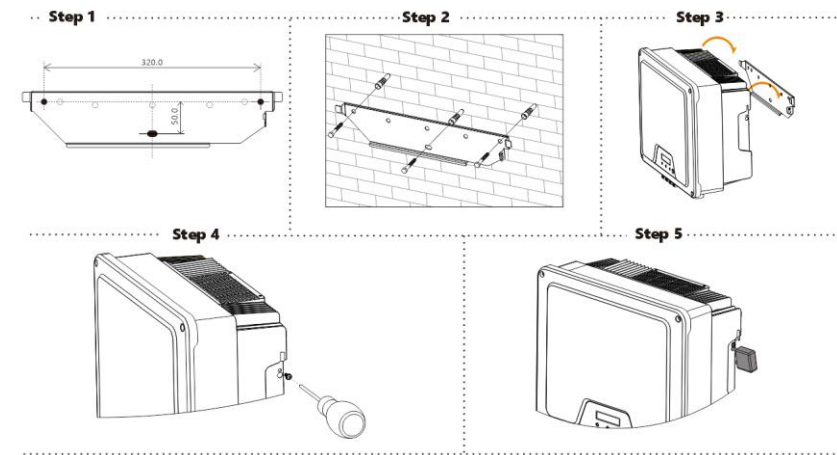

4.4 Installing the PE cable

1. Insert the grounding conductor into the suitable terminal lug and crimp the contact.
2. Align the terminal lug with the grounding conductor and the ground washer on the screw. The teeth of the ground washer must be facing the housing.
3. Tighten it firmly into the housing (screwdriver type: T25, torque: 2.5Nm).

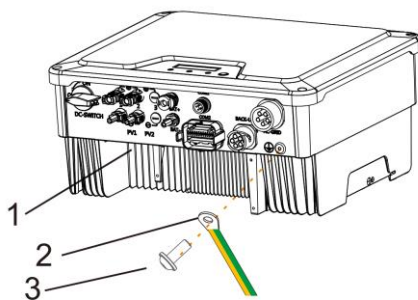

Information on grounding components:

Object	Description
1	Housing
2	Terminal lug with protective conductor
3	M6×16 pan head screw

PE Conductor cross-section: 10 mm²

5. COMMISSIONING

5.1 Safety Instructions

1. Measure the frequency and voltage of grid connection and make sure they follow the inverter's grid connection specifications.
2. An external circuit-breaker on the AC side (or a fuse) at 1.25*AC rated current is strongly recommended.
3. Reliability of all earth connections must be tested and valid.
4. Before commissioning, disconnect the inverter and the circuit-breaker or fuse, and prevent accidental reconnection.

The cable specification is shown as below:

No	Item	Type	Specification
1	PE cable	Outdoor copper cable	<ul style="list-style-type: none">• Conductor cross-section: 10mm²
2	AC Output cable	Outdoor copper cable	<ul style="list-style-type: none">• Conductor cross-section:• 5K:4~6 mm²;6~8K:6~8 mm²;• 10~12K:8~10 mm²
	BACK-UP Output cable	Outdoor copper cable	<ul style="list-style-type: none">• Conductor cross-section:• 5K:4~6 mm²;6~8K:6~8 mm²;• 10~12K:8~10 mm²
3	DC Input cable	Standard outdoor PV cable PV1-F Model recommended	<ul style="list-style-type: none">• Conductor cross-section: 2.5~6 mm²
	Battery Input cable	Standard outdoor PV cable PV1-F Model recommended	<ul style="list-style-type: none">• Conductor cross-section: 6 mm²
4	Meter/RS485/DRED	Outdoor shielded twisted pair cable	<ul style="list-style-type: none">• Conductor cross-section:0.14~1.0mm²

5.2 AC Wire Assembly and Connection

5.2.1 AC Commissioning

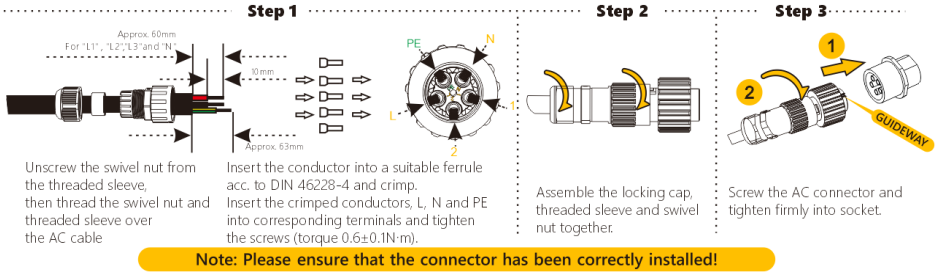

5.2.2 AC Switch Types

Please install an individual 2-stage miniature circuit breaker according to the following specifications.

Model	Maximum output current (A)	AC Breaker Rated current (A)
W-HHT -5000	17	50A/230V AC
W-HHT -6000	20	50A/230V AC
W-HHT -8000	22	63A/230V AC
W-HHT -10000	22	63A/230V AC
W-HHT-12000	23	63A/230V AC

5.3 Back-up Wire Assembly and Connection

5.3.1 Back-up Commissioning

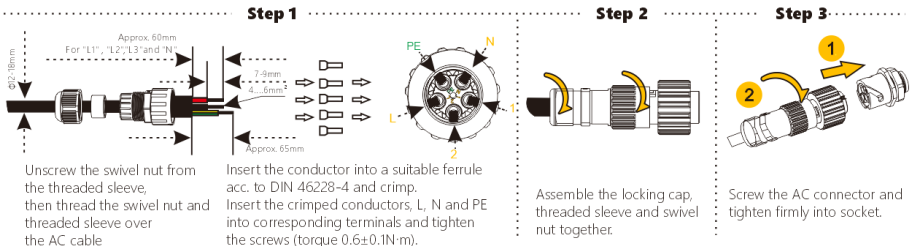

6.3.2 Back-up Switch Types

Please install an individual 2-stage miniature circuit breaker according to the following specifications.

Model	Maximum Back-up current (A)	Back-up Breaker Rated current (A)
W-HHT -5000	17	50A/230V AC
W-HHT -6000	20	50A/230V AC
W-HHT -8000	22	63A/230V AC
W-HHT -10000	22	63A/230V AC
W-HHT-12000	23	63A/230V AC

5.4 PV Wire Assembly and Connection

1. PV modules of the connected strings must be of: the same time, identical alignment and tilting angle.
2. Before commissioning and connecting the PV arrays, the DC switch MUST be open.
3. Parallel strings must have the same number of modules.
4. It is mandatory to use the DC connectors within package for the connection of PV arrays.
5. The polarity of the PV arrays MUST be compatible to the DC connectors of the inverter.
6. The DC input voltage AND DC input current of the PV array MUST never exceed the maximum input allowance of the inverter.

DC Commissioning:

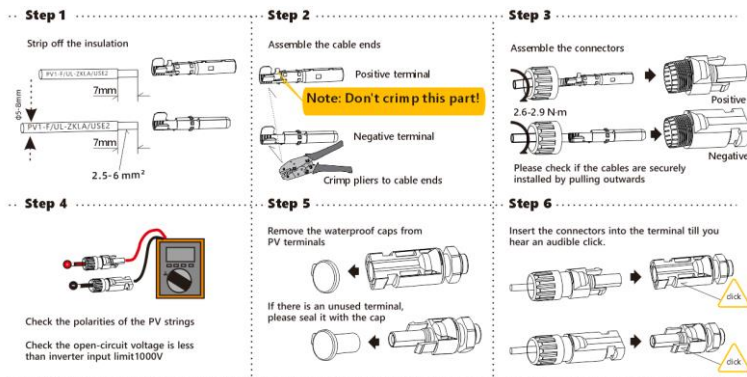

5.5 Battery Wire Assembly and Connection

1. Make sure there is an external DC breaker ($\geq 40A$) connected for battery without build-in DC breaker.
2. Make sure battery breaker is off and battery nominal voltage is less than 800V before connecting battery to inverter and make sure inverter is totally isolated from PV and AC power.
3. If the Battery connectors are not assembled properly and locked into place, arc or overheat may be induced.

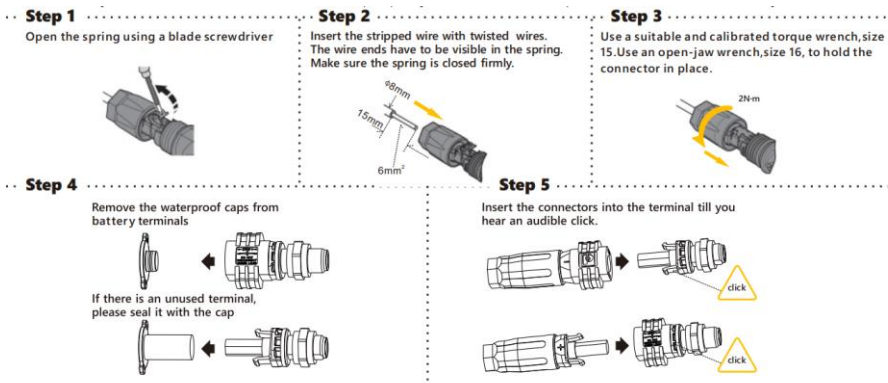

5.6 Residual Current Protection

This product is equipped with residual current protection device internally, in accordance with IEC 60364-7-714. An external residual current protection device is not needed. If the local regulation demands otherwise, it is recommended to install a 30mA Type B residual current protection device.

6. COMMUNICATION

6.1 System monitoring via Wi-Fi Stick - RS485/Wi-Fi /GPRS

6.1.1 Wi-Fi Stick Installation

1. Unpack the Wi-Fi Stick from package.
2. Unscrew the cap in COM1 port and plug the Wi-Fi Stick in and tighten.

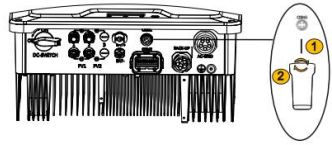

For user guidance and configuration of Wi-Fi Stick please refer to the corresponding Wi-Fi Stick Guide manual, which is available in printed form inside Documents pack, or on Western CO. website at www.western.it/en

6.1.2 RS485/CT/DRED Connection

Position

Step 1

Insert the wires into suitable ferrules (DIN 46228) and crimp.

Step 2

Insert the crimped conductors accordingly into their corresponding terminals and tighten the screws use the screwdriver in the attached bag.

<p>▶ CAN FOR COM2</p> <p>BMSCANH ▶ 14(CAN2H) BMSCANL ▶ 15(CAN2L)</p> <p>▶ CT FOR COM2</p> <p>U_CT+ ▶ 2(CT1+) U_CT- ▶ 3(CT1-) V_CT+ ▶ 4(CT2+) V_CT- ▶ 5(CT2-) W_CT+ ▶ 6(CT3+) W_CT- ▶ 7(CT3-)</p> <p>▶ METER FOR COM2</p> <p>MATERA ▶ 16(META) MATERB ▶ 17(METB)</p> <p>▶ DRED FOR COM2</p> <p>COMLOAD/O ▶ RJ451-7 REF GEN/O ▶ RJ451-8</p>	<p>▶ RS485 FOR COM2</p> <p>R5485A ▶ 9 R5485 ▶ 8</p>
-------------------------------------------------------------------------------------------------------------------------------------------------------------------------------------------------------------------------------------------------------------------------------------------------------------------------------------------------------------------------------------------------------------------------------------------------------------------------------	-------------------------------------------------------------------------

NOTICE

For parallel connections of multiple inverters via RJ45, use RJ45 port 1 and RJ45 port 2 on the COM2 connector. For the furthest inverter of such connection, only 1 port is occupied. The button on the side of the occupied port must be pushed to 'ON' for matched resistance.

			<p>▶ RS485 FOR COM1</p> <p>Power + ▶ PIN 1 Power - ▶ PIN2 RS485 A ▶ PIN3 RS485 B ▶ PIN4</p>
--	--	--	-------------------------------------------------------------------------------------------------------------------------------------------

Step 3

Assemble the locking cap, threaded sleeve and swivel nut together.

Step 4

Screw the connector into the socket and tighten firmly.

1. The arrow on the CT points to the inverter during installation.
 2. The white line on the CT is connected to "CT+", and the black line is connected to "CT-".



When installing RS485, the COM sealing plate needs to be removed. All operation **MUST NOT** proceed until AC and DC power is securely disconnected and discharged to prevent electric shocks.



IF the CT was connected to inverter incorrectly, inverter will output the warning code 22 or 23. The detail of how to connect CT can be seen in quick installation guide.

6.2 Auto Test (ONLY for Italian Market)

Auto-Test

1. The default setting of this function is disabled which can only be available in Italy safety, Short press the button until first Line of LCD displays "Auto Test", and long press (>2s) the button to start this function. First line of LCD displays "Auto Testing" and the second line of LCD displays "Start". Release the button for more than 10s, LCD will automatically switch to display the information about testing.
2. If auto test is finished, short press the button, Second line of LCD switches between "Start" and "Result". Under the "Result" display interface then release the button for more than 10s, LCD will automatically switch to display the result of auto test. and short press button to display test result one by one.
3. Auto test begin after the inverter relays close successfully. And LCD show the information about testing. If sub test finishes and second line of LCD displays "Test **** OK", The first line of LCD displays voltage or frequency test value and the value of protection time. Inverter relay breaks off and reconnect to grid automatically according to CEI 0-21 requirement, Then the next test starts. Test order is 81>.S1(maximum over frequency), 81>.S2(maximum over frequency), 81<.S1(minimum under frequency), 81<.S2(minimum under frequency), 59.S1(maximum voltage over 10min), 59.S2(maximum over voltage), 27.S1(minimum under voltage), 27.S2(minimum under voltage).

7. START UP AND OPERATION

7.1 Safety Check Before Start Up



Please check before switching on any voltage resources connected to the inverter and closing inverter's DC switch:

1. Grid Voltage: Check the grid voltage at point of connection at the inverter complies with permitted range of the inverter.
2. Mounting Bracket: Check if the mounting bracket is properly and securely installed.
3. Mounting of the inverter: Check if the inverter is properly mounted and attached to the mounting bracket.
4. DC Connectors: Check if the DC connectors are installed correctly on terminals.
5. Battery Connectors: Check if the Battery connectors are installed correctly on terminals.
6. Back-up Connector and Wire Assembly: Check if wires are assembled correctly on the Load side and if the Back-up connector is properly and securely installed. Check if the Back-up connector is firmly plugged into Back-up terminal.
7. AC Connectors and Wire Assembly: Check if wires are assembled correctly on the AC side and if the AC connector is properly and securely installed. Check if the AC connector is firmly plugged into AC terminal.
8. Cables: Check if all cables are reliably connected. Check if the connections are effective, while the insulations are undamaged.
9. Groundings: Check all groundings using multimeter and if all exposed metal parts of the inverter are properly grounded.
10. DC Voltage: Check if the largest open-circuit voltage of PV arrays complies with the permitted range.
11. DC Polarity: Check if the wires from DC voltage resource are connected to terminals with correct polarity.
12. Grounding Resistance: Check if the grounding resistance of PV strings $>1\text{M}\Omega$ using a multimeter.

After all installation and checks, close the AC circuit-breaker, then the DC switch. The inverter will start to operate when DC input voltage and grid conditions meet the requirements of inverter startup.

7.2 Inverter LED Indicators

When the inverter operates, LED symbols on display have the following meanings:

 POWER	<ul style="list-style-type: none"><input checked="" type="radio"/> ON Inverter Power ON and Feeding Power to Grid<input type="radio"/> Blink Inverter Power ON. Not Feeding Power to Grid<input type="radio"/> OFF Inverter Power OFF. DC Disconnected
 FAULT	<ul style="list-style-type: none"><input checked="" type="radio"/> ON Inverter is Faulty<input type="radio"/> OFF No Fault
 COM	<ul style="list-style-type: none"><input type="radio"/> Blink Communication Device Connected<input type="radio"/> OFF Communication Device Disconnected

7.3 Display and Control Logics

When inverter starts up and operates, there is a control button beside LCD Display of the inverter. Please follow the logics listed below.

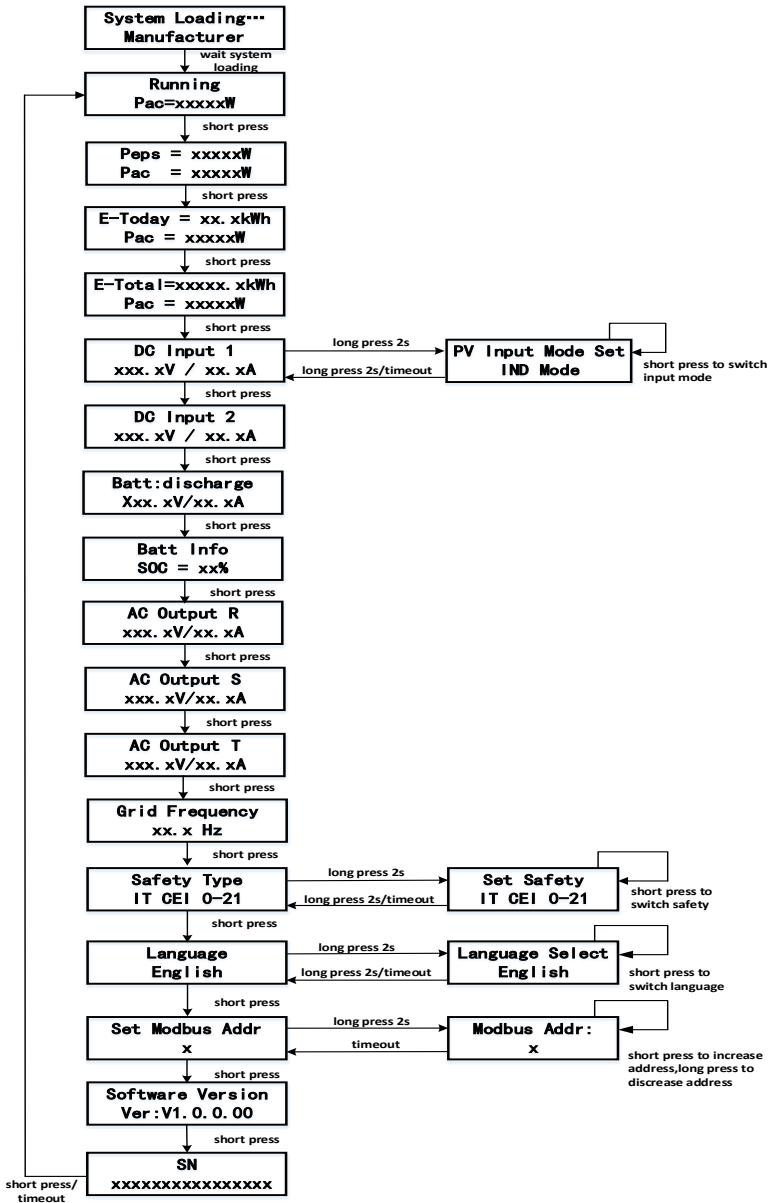

8. DISCONNECTING FROM VOLTAGE RESOURCES

Before proceeding any operations on inverter, please disconnect the inverter from all voltage resources as described in this manual.

Following these steps in described sequence are mandatory.

1. Disconnect miniature circuit-breaker and prevent from unintentional reconnections.
2. Disconnect all loads, unscrew and remove the Back-up connector.
3. Disconnect AC connections, unscrew and remove the AC connector.
4. Open the DC switch and prevent the switch from closing unintentionally.
5. Use clamps to ensure there is no electrical current in DC and Battery wires.
6. Disconnect all DC , Battery connections and resources. Unplug the DC connectors, and DO NOT pull the cables.



7. Use multimeter to ensure the voltage on DC terminals of inverter is 0.
8. Unscrew and remove the AC connector and Back-up connector.

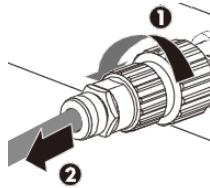

Danger to life due to high voltages.

Inverter capacitors need 5 minutes to be completely de-energized.

When an error occurs, DO NOT remove the cover of the inverter onsite. Improper operations and attempts may induce electric shock.

9. TECHNICAL PARAMETERS

Module	W-HHT-5K	W-HHT-6K	W-HHT-8K	W-HHT-10K	W-HHT-12K
INPUT/DC					
Max. PV Power (Wp)	7500	9000	12000	15000	18000
Max. Input Voltage (V)	1000				
MPP Voltage Range (V)	150~850				
Min. DC Voltage (V)	100/145				
Nominal DC-Input Voltage (V)	620				
Max. Input Current (A)	15 per string				
Max. short DC current (A)	20 per string				
No. of independent MPPT inputs	2				
No. of PV strings per MPPT	1				
BATTERY INPUT					
Battery type	Lithium				
Input voltage range(V)	160-800				
Max charging/discharging current(A)	25/25				
Charging strategy for Li-Ion battery	Self-adaption to BMS				
OUTPUT/AC					
Rated Power (W)	5000	6000	8000	10000	12000
Max. apparent AC power to Grid (VA)	5500	6600	8800	11000	13200
Max. active power from Grid (W)	10000	12000	15000	15000	18000
Max. apparent AC power from Grid (VA)	11000	13200	16500	16500	20000
Rated grid voltage (Vac)	380/400,3W/N/PE				
Rated power frequency (HZ)	50/60				
Max. output current (A)	8.5	10	13.5	16	20
Max. AC current from grid (A)	17	20	23	23	29
Adjustable displacement power factor	0.8ind to 0.8cap				
THDi at rated power	<3%				
OUTPUT/BACK-UP					
Rated Power (W)	5000	6000	8000	10000	12000

Max. apparent AC power to Grid (VA)	10000 for 1min	12000 for 1min	15000 for 1min	15000 for 1min	15000 for 1min
Rated grid voltage (Vac)	380/400,3W/N/PE				
Rated power frequency (HZ)	50/60				
Max. output current (A)	8.5	10	13.5	16	20
THDi at rated power	<3%				
EFFICIENCY					
Max. Efficiency	98.00%		98.20%		
Euro Efficiency	97.30%			97.40%	
MPPT Efficiency	99.90%				
PROTECTION					
Anti-islanding Protection	Integrated				
Input Reverse Polarity Protection	Integrated				
Insulation Resistor Detection	Integrated				
Residual Current Monitoring Unit	Integrated				
Output Over Current Protection	Integrated				
Output Short Protection	Integrated				
Output Over Voltage Protection	Integrated				
GENERAL DATA					
Dimensions(W*H*D) mm	425*351*200				
Weight (kg)	20				
Noise emission(typical) dB(A)	<25				
User Interface	LED				
DC connection type	MC4				
AC connection type	Plug-in Connector included				
Battery connection type	Sunclix				
Cloud Communication	Wi-Fi Stick included				
Cooling method	Fanless				
Operating ambient temperature range	-25°C....+60°C				
Allowable relative humidity range	0%-100%				
Max. operating altitude(m)	2000(>2000 derating)				
Degree of protection(IEC 60529)	IP65				

Climatic category (IEC 60721-3-4)	4K4H
Isolation method	Transformerless
Power loss in night mode	<13W

Inverter power quality response modes	
Power quality response modes	Default operation per AS/NZS 4777.2:2015
Volt-watt response mode	Default: Enabled
Volt-var response mode	Default: Disabled
Fixed power factor mode	Default: Disabled
Reactive power mode	Default: Disabled
Characteristic power factor curve for $\cos \varphi (P)$	Default: Disabled

10. TROUBLE SHOOTING

Earth Fault Alarm

This inverter complies with IEC 62109-2 clause 13.9 for earth fault alarm monitoring.

If an **Earth Fault Alarm** occurs, the **error code 6** will be displayed on the LCD. Red LED indicator will also light up.

Full Error Code and Corrective Measures

When the PV system does not operate normally, we recommend the following solutions for quick troubleshooting. If an error occurs, the Error code will be displayed on the inverter's screen, the red LED will light up. The corresponding corrective measures are as follows:

Error Code	Fault Name	Description	Corrective Measures
1	Functional fault in Micro-Controller Unit (MCU)	MCU abnormal self-check in start process	Disconnect the inverter from the utility grid and the PV array, and reconnect it after LED turns off. If this fault is still being displayed, please contact service.
2	A faulty current sensor detected	AC current sensor detect current abnormal in the start process	Disconnect the inverter from the utility grid and the PV array, and reconnect it after LED turns off. If this fault is still being displayed, please contact service.
3	Ground fault circuit interrupter (GFCI) sensor error	GFCI sensor self-check abnormal	Disconnect the inverter from the utility grid and the PV array, and reconnect it after LED turns off. If this fault is still being displayed, please contact service.
4	A faulty grid relay detected	The difference between INV voltage and output voltage exceeds limit.	<ol style="list-style-type: none"> 1. Disconnect the inverter from the utility grid and the PV array, and reconnect it after LED turns off. 2. If the fault persists, measure the phase to phase voltage and phase to zero and zero to ground voltage with a multimeter to ensure that the voltage is normal and the zero to ground voltage value should not be greater than 10V. 3. Disconnect the inverter from the utility grid and the PV array, and reconnect it after LED turns off. If this fault is still being displayed, please contact service.
5	PV voltage too high	When the PV voltage of any circuit is greater than 1020V, it is determined as the PV voltage is too high.	Check the open-circuit voltages of the strings and make sure it is below the maximum DC input voltage of the inverter. If the input voltage lies within the permissible range while the fault occurs, please contact the service.
6	Surface insulation resistance error	In the process of power on and start-up, the insulation impedance of PV + and PV - to ground is detected. When the detection insulation impedance is less than 200kohm, it is judged as insulation fault.	<ol style="list-style-type: none"> 1. If it happens occasionally, it may be caused by rainy or humid environment. After the fault is eliminated, the inverter can resume normal operation without other actions. 2. If there is continuous alarm, please check the PV array's insulation to ground and make sure that the insulation resistance to ground is greater than 200kΩ. Otherwise, visual inspection of all PV cables and modules. Make sure the grounding connection of the inverter is reliable. If all above are normal, please contact the service.
7	Ground fault circuit interrupter (GFCI) exceeds the permissible range	residual current over the permission range	<ol style="list-style-type: none"> 1. Make sure the grounding connection of the inverter is reliable. 2. Make a visual inspection of all PV cables and modules. If this fault is still shown, contact the service.
8	Inverter temperature too high	Heat sink and internal environment temperature higher than 90 degree	Please confirm: <ol style="list-style-type: none"> 1. Whether the airflow to the heat sink is obstructed. 2. Whether the installation site is in direct sunlight and ambient temperature around the inverter is too high. If all above is normal, contact the service.
9	Utility grid disconnected	inverter detected grid voltage failed	<ol style="list-style-type: none"> 1. If it happens occasionally, it belongs to the short-time abnormality of the power grid, the inverter will return to normal operation after detecting that the power grid is normal, and there is no need to deal with it. 2. If it cannot be recovered for a long time, please confirm: <ol style="list-style-type: none"> ① whether the AC circuit breaker is disconnected ② whether the AC terminal or fuse is in good contact

			③whether the power supply line is normal If this fault is still being shown, contact the service.
10	Grid voltage exceeds the permissible range	grid voltage exceeds the Safety regulations	<p>1. If it happens occasionally, it belongs to the short-time abnormality of the power grid, the inverter will return to normal operation after detecting the normal power grid, and there is no need to deal with it.</p> <p>2. In case of frequent occurrence but automatic recovery, please confirm if the grid voltage is outside the permissible range due to local grid conditions, try to modify the values of the monitored operational limits after informing the electric utility company first.</p> <p>3. If it cannot be recovered for a long time, please confirm:</p> <p>①whether the AC circuit breaker is disconnected</p> <p>②whether the AC terminal is in good connection</p> <p>③whether the power supply line is normal</p> <p>④whether the AC cable wiring (such as wire length and wire diameter) complies with the user manual guidance</p> <p>⑤whether the safety regulation settings are normal</p>
11	Grid frequency exceeds the permissible range	grid frequency exceeds the Safety regulations	<p>1. If it happens occasionally, it belongs to the short-time abnormality of the power grid, the inverter will return to normal operation after detecting the normal power grid, and there is no need to deal with it.</p> <p>2. In case of frequent occurrence but automatic recovery, please confirm if the grid voltage is outside the permissible range due to local grid conditions, try to modify the values of the monitored operational limits after informing the electric utility company first.</p> <p>3. If it cannot be recovered for a long time, please confirm:</p> <p>①whether the AC circuit breaker is disconnected</p> <p>②whether the AC terminal is in good connection</p> <p>③whether the power supply line is normal</p> <p>④ whether the safety regulation settings are normal</p>
12	DC component of the electricity exceeds the permissible range	the current exceeds 1A in stastic state and 4A in dynamic state	Disconnect the inverter from the utility grid and the PV array, and reconnect it after LED turns off. If this fault is still being displayed, please contact the service.
13	EEPROM Error, e.g. transition disturbance	Micro CPU read EEPROM failed	Disconnect the inverter from the utility grid and the PV array, and reconnect it after LED turns off. If this fault is still being displayed, please contact the service.
14	Internal communication fault	Master CPU communicate with slave CPU abnormal	Disconnect the inverter from the utility grid and the PV array, and reconnect it after LED turns off. If this fault is still being displayed, please contact the service.
15	Bus-voltage too high	Bus-voltage is greater than 1030V	Check the open-circuit voltages of the strings and make sure it is below the maximum DC input voltage of the inverter. If the input voltage lies within the permissible range while the fault occurs, please contact the service.
16	Bus-voltage too low	Bus-voltage is 20V lower than standard Bus-voltage	Check the open-circuit voltages of the strings and make sure it is below the maximum DC input voltage of the inverter. If the input voltage lies within the permissible range while the fault occurs, please contact the service.

17	DRM S9 Error	DRM switch S9 fault	Check the connection of DRM device. If the DRM device is connected normally while this fault occurs, please contact the service.
18	DRM S0 Error	DRM switch S0 fault	Check the connection of DRM device. If the DRM device is connected normally while this fault occurs, please contact the service.
19	N and PE voltage exceeds permitted range	Voltage between N and PE is over limit	Check if the inverter is securely grounded.
20	Bus Unbalance Error	Bus voltage is over limit	Disconnect the inverter from the utility grid and the PV array, and reconnect it after LED turns off. If this fault is still being displayed, please contact the service.
21	BMS Communication Error	Battery BMS communication interrupted	Check the connection of BMS cable with storage inverter. If the BMS cable is connected normally while this fault occurs, please contact the service.
22	CT or Meter Null Error	Current transducer not connected	Check the connection of CT or Meter device. If the CT or Meter is connected normally while this fault occurs, please contact the service.
23	CT Reverse Error	Current transducer reverse connection	Try to change the direction of CT device. If the CT device is connected correctly while this fault occurs, please contact the service.
24	Battery Null Error	Battery disconnection	Check the connection of battery. If the battery is connected normally while this fault occurs, please contact the service.
25	Back-up load over-voltage	Back-up voltage exceeds the normal range	Check whether the Back-up output voltage exceeds the normal range. If the Back-up output voltage normally while this fault occurs, please contact the service.

11. SYSTEM MAINTENANCE

For the inverter's long-term performance, it is suggested to maintain your inverter regularly:

NOTICE:

HEAT SINK MIGHT INDUCE INJURY

When the inverter is operating, the heat sink might exceed 60°C

- Please disconnect all electrical cables and connections. Wait for the inverter to cool down completely.
- Use compressed air cleaning or a soft brush to clean the inverter heat sink.
- ALL aggressive chemicals, cleaning solvents or strong detergents are FORBIDDEN

Content	Maintenance Measures	Cycle
System Cleaning	<ul style="list-style-type: none">• Check if the heat sink is covered and dusted• Maintenance of DC Switch can be performed at night. Turn the switch to ON and OFF positions for 4~5 times.• Use a wet cloth to clean the display	Annually OR Half a year
System Status	<ul style="list-style-type: none">• Inspect the enclosure for damage/deformation• Listen for abnormal noises during operation• Check if the parameters are normal during operation	Half a year
Commissioning	<ul style="list-style-type: none">• Check if the cables are loose• Check if the cable insulations are damaged, especially the parts in contact with metal surfaces	Half a year after first commissioning Annually OR Half a year
Grounding	<ul style="list-style-type: none">• Check if the cables are securely grounded	Half a year after first commissioning Annually OR Half a year

12. RESTARTS

When reconnecting the inverter for electrical power supply, please follow the commissioning procedures and safety instructions as described in **Section 5** when applicable (e.g. DC Wires need to be reassembled).

Please run safety checks as described in **Section 8** before closing the DC Switch and starting up again.

13. LEGAL WARRANTIES

Western CO. srl guarantees the good quality and the good construction of the Products by obliging itself, during the warranty period of 5 (five) years, to repair or replace at its sole discretion, free of charge, parts which, due to bad quality of the material or manufacturing defects, prove to be defective.

The defective product must be returned to Western CO. srl or to a company delegated by Western CO. srl to service the product, at the customer's expense, together with a copy of the sales invoice, both for repair and guaranteed replacement. The costs of re-installation of the material will be borne by the customer.

Western CO. srl will bear the shipping costs of the repaired or replaced product.

The warranty does not cover Products which, at our discretion, are defective due to natural wear and tear, failures caused by inexperience or negligence on the customer's end, imperfect installation, tampering, or incorrect maintenance of the system or interventions other than the instructions provided by us.

The warranty is also forfeited in the event of damage resulting from:

- transport and/or poor conservation of the product.
- force majeure or catastrophic events (freezing temperatures below -20°C, fire, floods, lightning, vandalism, etc.).

All the above warranties represent the only agreement that supersedes any other proposal or verbal or **written agreement and any other communication between the manufacturer and the purchaser in respect of the above.**

Any dispute is resolved by the competent court of Ascoli Piceno.

14. WASTE DISPOSAL

Western CO. as a manufacturer of the electrical device described in this manual, and in accordance with Italian L.D. no. 151 25/07/05, informs the purchaser that once this product is disposed of, must be delivered to an authorised collection centre or, if equivalent equipment is purchased, it can be returned free of charge to the distributor of the new equipment.



Penalties for disposing of electronic refusals illegally will be applied by the individual municipalities.



WESTERN CO. S.r.l.

Via Pasubio, 1
63074 San Benedetto del Tronto (AP)
tel. (+39) 0735 751248
fax. (+39) 0735 751254
e-mail: info@western.it
web: www.western.it