

Quick Installation Guide

SG110CX

PV Grid-connected Inverter

SG110CX-QIEN-Ver15-202106 Version: 1.5



This guide is valid for inverters SG110CX, providing the installation, electrical connection, commissioning and troubleshooting procedure.

⚠ NOTICE

- Contents may be periodically updated or revised due to product development, The information in this guide is subject to change without notice. In no case shall this guide substitute for the user manual or related notes on the device.
- Make sure to read over, fully understand and strictly follow the detailed instructions of the user manual and other related regulations before installing the equipment. The user manual can be downloaded by visiting the website at <http://support.sungrowpower.com/>; or it can be obtained by scanning the QR code on the side of the equipment or the back cover of this guide.
- All operations can be performed only by qualified personnel, that must be trained in the installation and commissioning of the electrical system, as well as the dealing with hazards, have knowledge of the manual and of the local regulations and directives.
- Before installation, check that the package contents are intact and complete against the packing list, Contact SUNGROW or the distributor in case of any damaged or missing components.
- The cable must be intact and well insulated, Operation personnel must wear proper personal protective equipment (PPE) all the time.

1 Product Introduction

1-1 Appearance

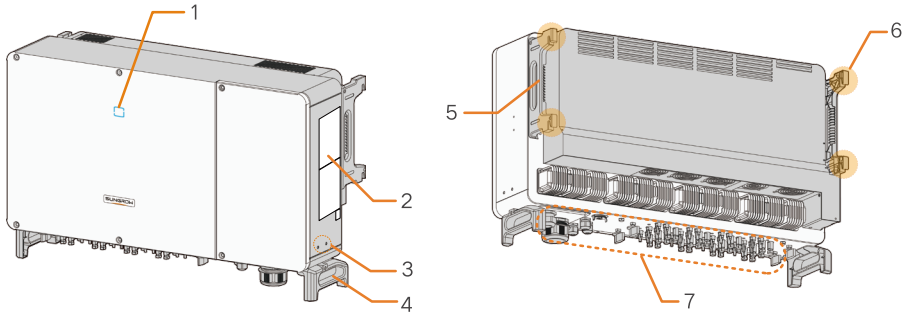

1. LED indicator 2. Warning symbols, nameplate, and QR code 3. Additional grounding terminals 4. Bottom handles
 5. Side handles 6. Mounting ear 7. Wiring area

*Devices for Australia and New Zealand are not equipped with DC switches.

1-2 Dimensions

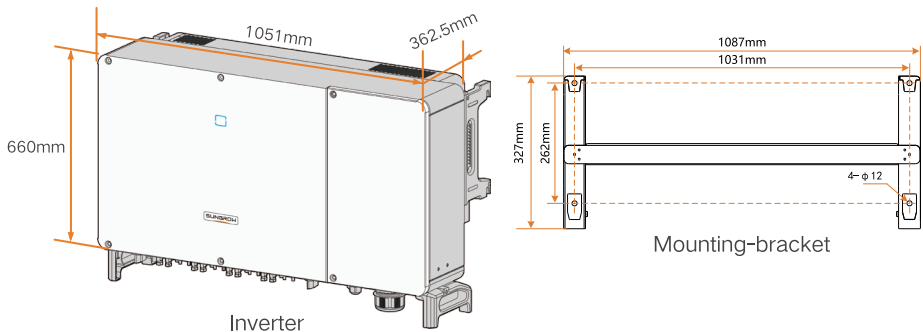

*The image shown here is for reference only. The actual product you receive may differ.

2 Mechanical Mounting

2-1 Location Selection

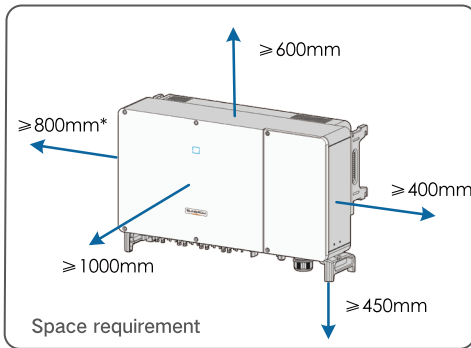
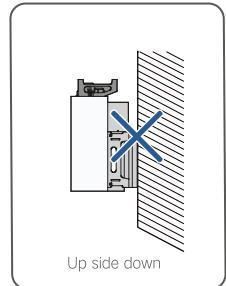
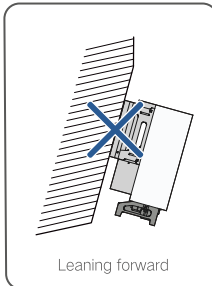
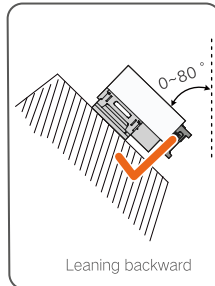
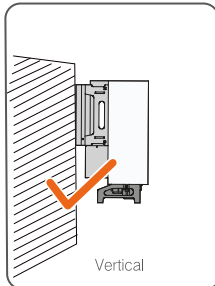
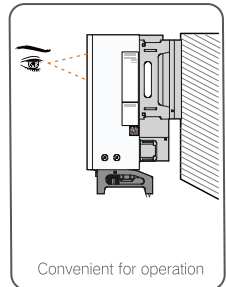
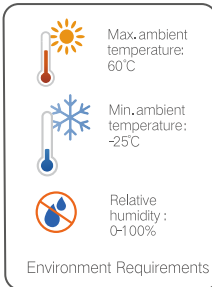
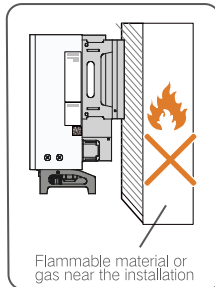
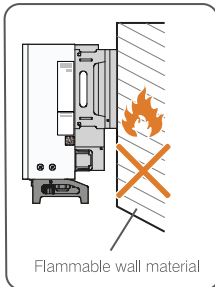

i * In case the distance is less than 800mm, move the inverter from the mounting-bracket or wall before maintaining fans.

2-2 Installation

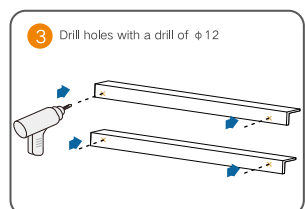
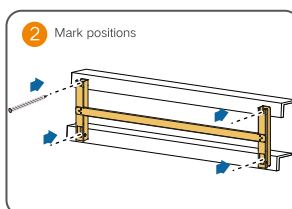
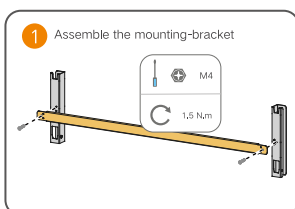

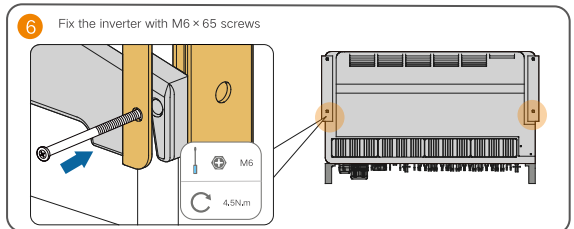
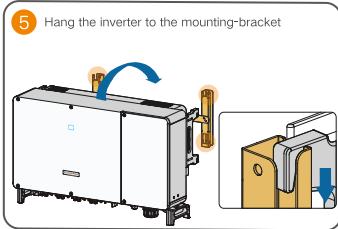
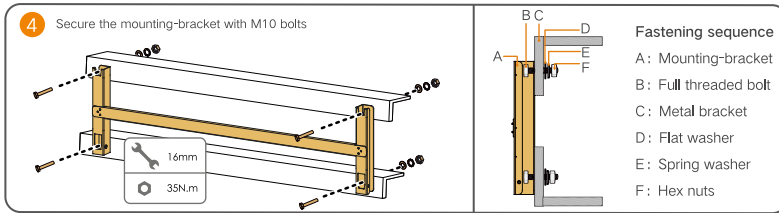

3 Electrical Connection

Overview

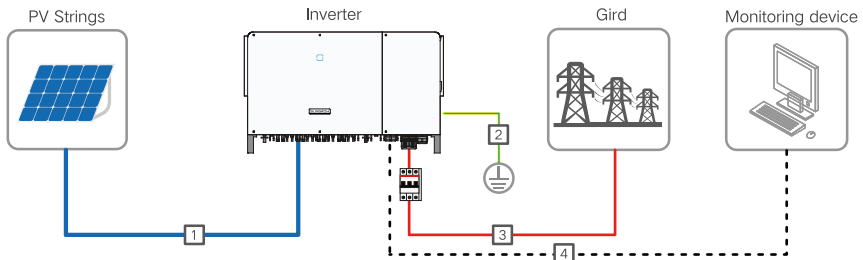

3-1 Cable requirements

No	Cable	Type	Outer diameter(mm)	Cross section(mm ²)
1	DC cable	PV cable complying with 1,500V standard	6~9	4~6
2	Additional grounding cable	Outdoor single-core copper wire cable	The same as that of the PE wire in the AC cable	
3	AC cable	Outdoor multi-core copper or aluminium cable	38~56	L1,L2,L3,N : 70~240 PE wire: Depends on phase wire cross-section S. When 16 < S ≤ 35, it is 16, When S > 35, it is S/2.
4	Communication cable	Shielded twisted pair (terminal block) CAT-5 Ethernet cable (RJ45)	4,5~18	1~1,5 /

⚠ NOTICE

- The DC cable must be a multi-core cables.

3-2 Additional Grounding Connection

⚠ NOTICE

- Since the inverter is a transformerless inverter, neither the negative pole nor the positive pole of the PV string can be grounded. Otherwise, the inverter will not operate normally.
- There are two terminals. Use at least one of them to ground the inverter.
- Apply paint to the grounding terminal to ensure corrosion resistance after connection.

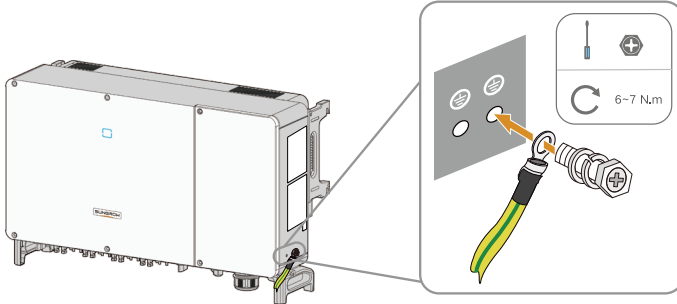

3-3 Opening the Wiring Compartment

Step 1 Release two screws on the front cover of the wiring compartment with supplied Allen wrench. Open the wiring compartment.

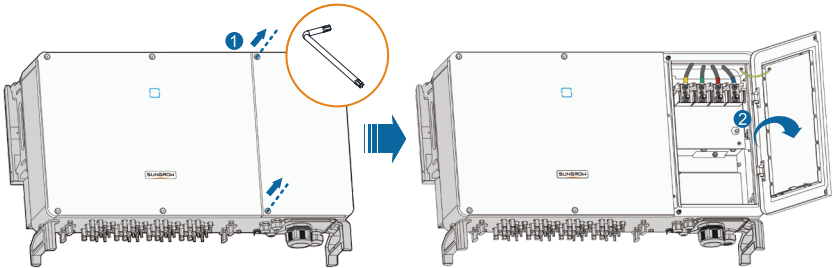

Step 2 Keep the wiring compartment opened during wiring through the limit lever attached to the cover.

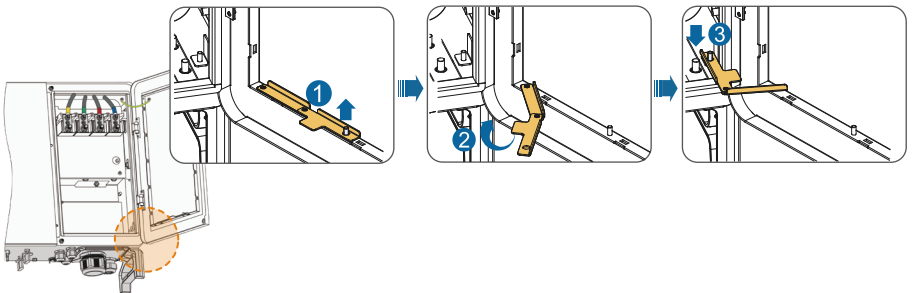

*Close the wiring compartment in reverse order after completing wiring operations.

3-4 AC Connection

⚠ NOTICE

- Before connecting the inverter to the grid, ensure the grid voltage and frequency comply with requirements.
- Disconnect the AC-side circuit breaker and prevent it from inadvertent reconnection.
- Observe the pin assignment of AC terminal block. If a phase wire is connected to the "PE" terminal, it may permanently damage the inverter.
- Please avoid squeezing the cable insulation layer into the AC terminal. Improper connection may affect the normal operation of the inverter.
- During AC cable connection, the cables inside the lower part of the device should be bended to be surplus in length. In this way, cable dropping or loosening, which can cause arc or other problems impairing functionality of the device, due to self-weight of the cables in case of land subsidence is avoided.
- If an aluminium cable is selected, use a copper to aluminium adapter terminal to avoid direct contact between the copper bar and the aluminium cable. See user manual for more details.

1 Lead the cable through the swivel nut

2 (If available) Remove the protection cover and store the released screws properly.

3 Strip the protection layer and insulation layer

4 Install the heat shrink tubing and OT/DT terminal

5 Crimp the OT/DT terminal

6 Fixed heat shrink tubing

7 Fix the AC cable to the corresponding terminals

8 Fasten the swivel nut, install the protection cover.

3-5 DC connection

⚠ NOTICE

- Use the MC4 DC terminal within the scope of delivery. Damage to the device due to the use of incompatible terminal shall not be covered by the warranty.
- There is a risk of inverter damage! The following requirements should be met. Failure to do so will void guarantee and warranty claims.
 - (1) Ensure that the open circuit voltage in any case does not exceed the inverter input upper limit of 1100V.
 - (2) Make sure the maximum short circuit current on the DC side is within the permissible range.
 - (3) Make sure the to-ground insulation performance of the PV string is sound.
- The inverter will not function properly if the DC polarities are reversed.
- If the PV connectors are not assembled into place, it may cause an arc or overheat. The loss caused by this issue will void the warranty.

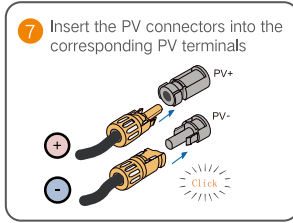
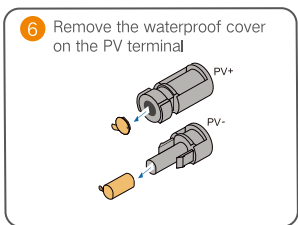
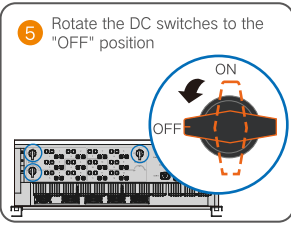
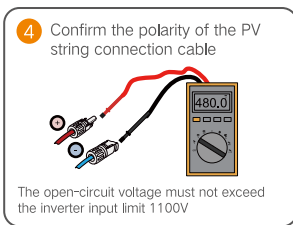
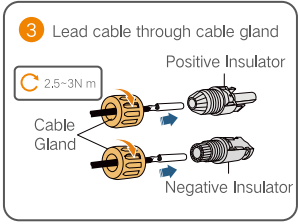
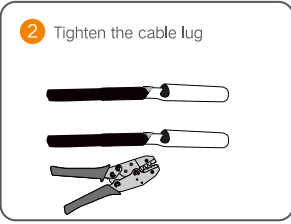
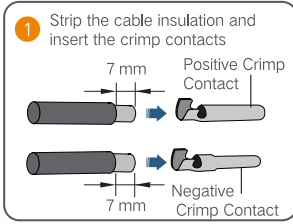

i Devices for Australia and New Zealand are not equipped with DC switches.

3-6 RS485 Communication Connection

The inverter is equipped with two groups of RS485 communication interfaces for external communication connection. Both the two groups of interfaces can be connected to the data collector (Logger), to achieve data exchange with PC or other monitoring devices. When multiple inverters are connected in the RS485 daisy chain, a 120Ω terminating resistor can be connected between the A and B communication cable through the RS485-dip switch, to ensure communication quality.

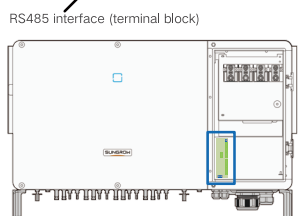
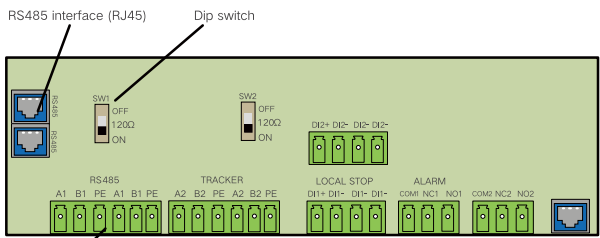

i RS485 terminal block interface and RJ45 interface serve as the same function with wiring manner different.

Terminal Block

- 1 Loosen the swivel nut of the communication terminal and select an appropriate seal

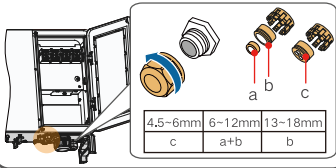

- 2 Lead the cable through the swivel nut



- 3 Strip the cable jacket and insulation layer

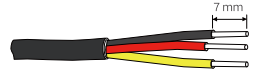

- 4 Secure the cable to the terminal base

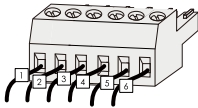

1: RS485 A IN 2: RS485 B IN 3: PE
4: RS485 A OUT 5: RS485 B OUT 6: PE

- 5 Insert the terminal base into the corresponding terminal

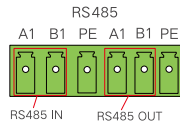

- 6 Fasten the swivel nut

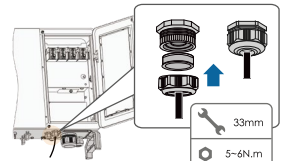

RJ45

- 1 Loosen the swivel nut of the communication terminal and select an appropriate seal

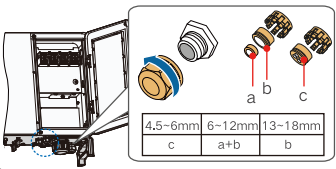

- 2 Lead the cable through the swivel nut



- 3 Crimp the crystal head according to the definition of the core pin

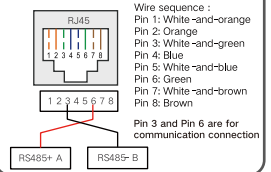

- 4 Insert the RJ45 connector to the RJ45 terminal.

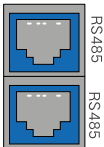

- 5 Fasten the swivel nut

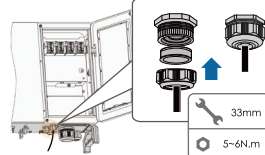

NOTICE

- There are three RS485 communication terminals, and the marks are COM1/COM2/COM3. Please choose according to the actual situation.

4 Commission

4-1 Inspection before Commissioning

No.	Items	Result	
		Yes	No
1	All equipment has been reliably installed.	<input type="checkbox"/>	<input type="checkbox"/>
2	DC and AC switches are in the "OFF" position.	<input type="checkbox"/>	<input type="checkbox"/>
3	The ground cable is properly and reliably connected.	<input type="checkbox"/>	<input type="checkbox"/>
4	The AC cable is properly and reliably connected.	<input type="checkbox"/>	<input type="checkbox"/>
5	The DC cable is properly and reliably connected.	<input type="checkbox"/>	<input type="checkbox"/>
6	The communication cable is properly and reliably connected.	<input type="checkbox"/>	<input type="checkbox"/>
7	The vacant terminals are sealed.	<input type="checkbox"/>	<input type="checkbox"/>
8	No foreign items, such as tools, are left on the top of the machine or in the junction box (if there is).	<input type="checkbox"/>	<input type="checkbox"/>
9	The AC circuit breaker is selected in accordance with the requirements of this manual and local standards.	<input type="checkbox"/>	<input type="checkbox"/>
10	All warning signs & labels are intact and legible.	<input type="checkbox"/>	<input type="checkbox"/>

4-2 Commissioning Procedure

Step1 Connect the AC switch between the inverter and the grid.

Step2 Rotate the DC switch of the inverter to "ON" position.

*Skip performing step1 when the actual device is not equipped with DC switches.

Step3 Connect the DC switch (if applicable) between the inverter and the PV string.

Step4 Set initial protection parameters via the iSolarCloud APP. If the irradiation and grid conditions meet requirements, the inverter will normally operate.

Step5 Observe the LED indicator to ensure that the inverter operates normally.

LED indicator description

	Steady blue	The device is connected to the grid and operating normally.
	Periodical flashing blue (Period: 0.2s)	The Bluetooth communication is connected and there is data communication. No inverter fault occurs.
	Periodical flashing blue (Period: 2s)	The DC or AC side is powered on and the device is in standby or startup state (not feeding power into the grid).
	Steady red	A fault occurs and the device cannot connect to the grid.
	Flashing red	The Bluetooth communication is connected and there is data communication. Fault occurs.
	OFF	Both the AC and DC sides are powered down.

5 iSolarCloud

5-1 Brief Introduction

The iSolarCloud APP can establish communication connection to the inverter via the Bluetooth, thereby achieving near-end maintenance on the inverter. Users can use the APP to view basic information, alarms, and events, set parameters, or download logs, etc.

*In case the communication module Eye, WiFi or WiNet-S is available, the iSolarCloud APP can also establish communication connection to the inverter via the mobile data or WiFi, thereby achieving remote maintenance on the inverter.

5-2 Download and Install

Method 1 : Scan the right QR code to download and install the APP.

Method 2 : Download the APP through the following application stores:

- MyApp (Android, mainland China users)
- Google Play (Android, users other than mainland China ones)
- APP store (iOS)



5-3 Initialize protection parameter

NOTICE

- To log in to the app, the following conditions must be met:
 - (1) The AC and DC sides or the AC side of the inverter is powered-on.
 - (2) The mobile phone is within 5m away from the inverter and there are no obstructions in between.
 - (3) The Bluetooth function of the mobile phone is enabled.

Step1 After the installation is complete, click "Open" or click the phone desktop APP icon to open the app.



iSolarCloud

Step2 Open the APP, after which the Bluetooth search screen pops up automatically, and select the to-be-connected inverter according to the SN on the nameplate of the inverter. The Bluetooth indicator gets on once the connection is established. Alternatively, tap "QR" to scan the QR code on the side of the inverter to establish Bluetooth connection.

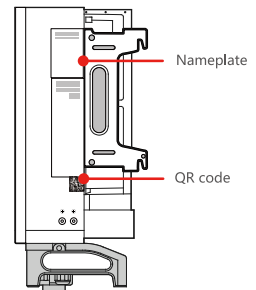
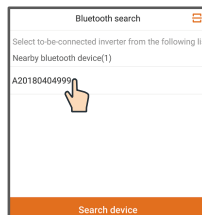
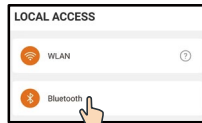
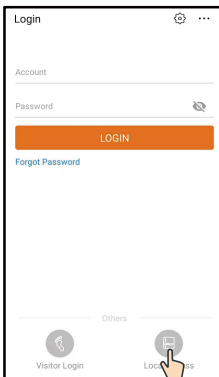

Step3 Enter the username and login password, click Login and proceed to the next step.

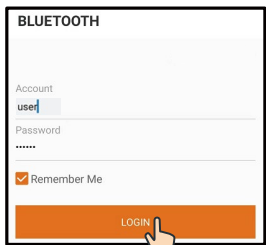

Login

Step4 After logging in, enter the initialization protection parameter setting interface, as shown in the figure. After finishing setting on the quick setting screen, click " Boot " and the device will be initialized. The APP will send start instructions and the device will start and operate.

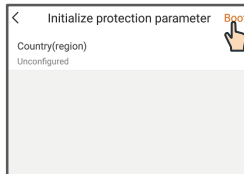

Initialization protection parameter

NOTICE

- The user name is "user" and the initial password is "pw1111". To ensure account security, please change the password as soon as possible.
- Reset the protection parameters if the country setting is incorrect. Otherwise, fault may occur.
- In the European region, such as Sweden, Ireland, Hungary, Portugal, Romania, Greece, Ukraine etc. whose grid code complies with EN50549, select the parameter EN50549_1 (LV grid-connection) or EN50549_2 (MV grid-connection) with proper manual settings.
- In the Brazilian region, set the country code to "Brazil". Selecting "Brazil_230" or "Brazil_240" will cause setting failure.

Step5 If the inverter is initialized, the APP automatically turns to its home page.



Home page

*Screenshots in this manual are based on the Android system V2.1.6, and the actual interfaces may differ.

Sungrow Power Supply Co., Ltd.
EU/EEA Importer: Sungrow Deutschland GmbH

Web: www.sungrowpower.com

Add: Balanstrasse 59, 81541 München, Germany



More information in the QR code or
at <http://support.sungrowpower.com/>

SUNGROW

Specifications are subject to changes without advance notice.



OIEN.MH-001478