

# HITACHI

# — INSTALLATION AND OPERATION MANUAL

**air**H<sub>2</sub>O 600 **S SERIES**

INDOOR UNITS

**MODELS**

**SPLIT SYSTEM**

RWM-(1.5-10.0)(N/R)3E



Cooling & Heating

air



## Contents

<b>01</b>	General information .....	1
<b>02</b>	Name of parts and dimensional data.....	8
<b>03</b>	Electrical data .....	12
<b>04</b>	Working range .....	16
<b>05</b>	Refrigerant and water piping .....	25
<b>06</b>	Electrical and control settings .....	47
<b>07</b>	Maintenance.....	71
<b>08</b>	Commissioning .....	77
<b>09</b>	ERP Data .....	84

## EN

The English version is the original one; other languages are translated from English. Should any discrepancy occur between the English and the translated versions, the English version shall prevail.

## ES

La versión en inglés es la original, y las versiones en otros idiomas son traducciones de la inglesa. En caso de discrepancias entre la versión inglesa y las versiones traducidas, prevalecerá la versión inglesa.

## DE

Die englische Fassung ist das Original, und die Fassungen in anderen Sprachen werden aus dem Englischen übersetzt. Sollten die englische und die übersetzten Fassungen voneinander abweichen, so hat die englische Fassung Vorrang.

## FR

La version anglaise est la version originale; les autres langues sont traduites de l'anglais. En cas de divergence entre les versions anglaise et traduite, la version anglaise prévaudra.

## IT

La versione inglese è l'originale e le versioni in altre lingue sono traduzioni dall'inglese. In caso di divergenze tra la versione inglese e quelle tradotte, fa fede la versione inglese.

## PT

A versão inglesa é a original; as versões em outras línguas são traduzidas do inglês. Em caso de divergência entre a versão em língua inglesa e as versões traduzidas, faz fé a versão em língua inglesa.

## DA

Den engelske udgave er originalen, og udgaverne på andre sprog er oversat fra engelsk. Hvis der forekommer uoverensstemmelser mellem den engelske og den oversatte sprogudgave, vil den engelske udgave være gældende.

## NL

De Engelse versie is de originele; andere talen zijn vertaald uit het Engels. In geval van verschillen tussen de Engelse versie en de vertaalde versies, heeft de Engelse versie voorrang.

## SV

Den engelska versionen är originalet, och versionerna på andra språk är från engelska översättningar. I händelse av bristande överensstämmelse mellan den engelska och den översatta versionerna, skall den engelska versionen vara giltig.

## EL

Η αγγλική έκδοση είναι το πρωτότυπο και οι εκδόσεις σε άλλες γλώσσες μεταφράζονται από τα αγγλικά. Σε περίπτωση που διαπιστωθούν διαφορές μεταξύ της αγγλικής και της μεταφρασμένης έκδοσης, η αγγλική έκδοση είναι επικρατέστερη.

## BG

Версията на английски език е оригиналната; версиите на останалите езици са в превод от английски език. При различие между английската версия и преводна версия на друг език за меродавна се счита английската версия.

## CS

Originální verze tohoto dokumentu je v angličtině; ostatní jazykové varianty jsou z angličtiny přeložené. Pokud mezi anglickou a jakoukoli jinou jazykovou verzí dojde k rozporu, bude směrodatná anglická verze.

## ET

Originaalversioon on ingliskeelne; teised keeled on tõlge inglise keelest. Vastuolude korral ingliskeelse ja tõlkeversioonide vahel kehtib eesõiguslikult ingliskeelne versioon.

## HU

Az eredeti változat az angol; az egyéb nyelvű változatok angolról lettek fordítva. Amennyiben az angol és a fordított verziók között bármilyen eltérés mutatkozik, az angol nyelvű változat a mérvadó.

## LV

Angļu valodas versija ir oriģinālā; no citām valodām tiek tulkotas uz angļu valodu. Ja starp angļu valodu un tulkoto versiju rodas jebkādas neatbilstības, noteicošais ir angļu valodas variants.

## LT

Versija anglų kalba yra originali; versijos kitomis kalbomis yra išverstos iš anglų kalbos. Jei yra neatitikimų tarp versijos anglų kalba ir verstinių versijų, pirmenybė teikiama versijai anglų kalba.

## PL

Wersja angielska jest wersją oryginalną - wszystkie pozostałe stanowią jej tłumaczenie na odpowiednie języki. W przypadku stwierdzenia jakichkolwiek rozbieżności między oryginałem a jego tłumaczeniem, rozstrzygająca jest wersja w języku angielskim.

## RO

Versiunea originală este cea în limba engleză; versiunile în alte limbi sunt traduse din limba engleză. Dacă există vreo discrepanță între versiunile în limba engleză și versiunea tradusă, prevalează versiunea în limba engleză.

## FI

Englanninkielinen versio on alkuperäinen; muut kielet on käännetty englannista. Mikäli englannin ja käännettyjen versioiden välillä ilmenee eroavaisuuksia, englanninkielinen versio on voimassa.

## HR

Verzija na engleskom jeziku prvobitna je verzija, a verzije na ostalim jezicima prevedene su s engleskog. U slučaju neslaganja između verzije na engleskom jeziku i prevedenih verzija, verzija na engleskom jeziku ima prednost.

## SK

Anglická verzia je pôvodná, ďalšie jazyky sú preložené z angličtiny. V prípade akýchkoľvek nezrovnalostí medzi anglickou a preloženou verzou, bude rozhodujúca anglická verzia.

## UK

Англійська версія є оригінальною; інші мови переведені з англійської. У разі виникнення розбіжностей між англійською та перекладеною версіями, англійська версія має переважну силу.

## TR

İngilizce sürüm orijinal olup diğer diller İngilizce'den çevrilmiştir. İngilizce sürüm ile çevrilen sürümlerin çelişmesi durumunda İngilizce sürüm esas alınacaktır.

## NO

Den engelske versjonen er originalen. Andre språk er oversatt fra engelsk. Ved eventuelle avvik mellom den engelske versjonen og en oversatt versjon, har den engelske versjonen forrang.

EN	English	Original version
ES	Español	Versión traducida
DE	Deutsch	Übersetzte Version
FR	Français	Version traduite
IT	Italiano	Versione tradotta
PT	Português	Versão traduzida
DA	Dansk	Oversat version
NL	Nederlands	Vertaalde versie
SV	Svenska	Översatt version
EL	Ελληνικά	Μεταφρασμένη έκδοση
BG	Български	Преведена версия
CS	Čeština	Přeložená verze
ET	Eesti	Tõlgitud versioon
HU	Magyar	Lefordított változat
LV	Latviešu	Tulkotā versija
LT	Lietuvių	Versta versija
PL	Polski	Tłumaczenie wersji oryginalnej
RO	Română	Versiune tradusă
FI	Suomi	Käännetty versio
HR	Hrvatski	Prevedena verzija
SK	Slovenčina	Preložená verzia
UK	Українська	Перекладена версія
TR	Türkçe	Çevrilmiş sürüm
NO	Norsk	Oversatt versjon

## General Index

1. General information .....	1
1.1 General information .....	2
1.1.1 General notes .....	2
1.2 Applied symbols.....	3
1.3 Additional information about safety .....	4
1.4 Important notice.....	5
1.5 Product guide .....	6
1.5.1 Classification of the units .....	6
1.5.1.1 Split system- Indoor unit- <b>airH2O 600S</b> .....	6
1.5.2 Product list.....	6
1.5.2.1 Split system- Indoor unit- <b>airH2O 600S</b> .....	7
2. Name of parts and dimensional data .....	8
2.1 <b>airH2O 600S</b> RWM-(1.5-3.5)R3E.....	9
2.2 <b>airH2O 600S</b> RWM-(3.5-6.0)R3E.....	10
2.3 <b>airH2O 600S</b> RWM-(8.0/10.0)N3E .....	11
3. Electrical data .....	12
3.1 Considerations.....	13
3.2 <b>airH2O 600S</b> - RWM-(1.5-6.0)R3E .....	14
3.3 <b>airH2O 600S</b> - RWM-(8.0/10.0)N3E .....	15
4. Working range .....	16
4.1 Power supply working range .....	17
4.2 Temperature working range.....	17
4.2.1 Space heating .....	17

4.2.2	DHW.....	19
4.2.3	Swimming pool heating.....	20
4.2.4	Space cooling (Necessary cooling kit).....	21
4.3	Hydraulic working range.....	22
4.3.1	Hydraulic data.....	22
4.3.2	Pump performance curves.....	23
5.	Refrigerant and water piping.....	25
5.1	General notes before performing piping work.....	26
5.2	R410A Refrigerant circuit.....	27
5.3	Refrigerant circuit.....	28
5.3.1	General notes R32 refrigerant.....	28
5.4	Refrigerant piping.....	28
5.4.1	Refrigerant piping size.....	28
5.4.2	Refrigerant piping length between indoor unit and outdoor unit (for R32 units).....	29
5.4.2.1	Minimum floor area for R32 units.....	32
5.4.3	Refrigerant piping length between indoor unit and outdoor unit (R410A units).....	36
5.5	Refrigerant charge.....	37
5.5.1	Refrigerant charge amount.....	37
5.5.1.1	Refrigerant charge before shipment ( $W_0$ (kg)).....	37
5.6	Water piping.....	37
5.6.1	Water piping length.....	37
5.6.2	Water piping size.....	37
5.6.3	Water quality for primary (space heating / cooling) and secondary (DHW) circuit.....	38

5.6.3.1	Water filling .....	39
5.6.4	Requirements and recommendations for the hydraulic circuit.....	41
5.6.5	Water flow control.....	43
5.7	Space heating and DHW.....	43
5.7.5.1	Additional hydraulic necessary elements for space heating ...	43
5.7.5.2	Additional hydraulic optional elements (For DHW).....	46
6.	Electrical and control settings .....	<b>47</b>
6.1	General check.....	48
6.2	Electrical connection .....	50
6.2.1	Wiring size .....	50
6.2.2	Minimum requirements of the protection devices .....	52
6.3	Setting of DIP switches and RSW switches.....	54
6.3.1	Location of DIP switches and rotary switches.....	54
6.3.1.1	Function of DIP switches and rotary switches .....	54
6.3.1.2	LED indication.....	58
6.4	Terminal board connections.....	59
6.4.1	Table board 1 .....	59
6.4.2	Table board 2 .....	60
6.4.2.1	Indoor/outdoor communication wiring (TB2) / ATW-RTU Communication / Central Devices Communication .....	60
6.4.2.2	Summary of terminal board connections .....	61
6.4.2.3	Input terminals (Default input functions) .....	63
7.	Maintenance.....	<b>71</b>
7.1	Removing the covers .....	72
7.1.1	Removing the indoor unit service cover .....	72
7.2	Removing indoor unit electrical box .....	73



7.3	Space heating pipes connection .....	74
7.4	Drain pipes connection.....	74
7.5	Cover assembly.....	75
7.6	Test and check .....	76
8.	Commissioning .....	<b>77</b>
8.1	Before operation.....	78
8.2	Preliminary check .....	78
8.2.1	Checking the unit.....	78
8.2.2	Electrical checking.....	78
8.2.3	Hydraulic circuit checking (space heating and DHW) .....	79
8.2.4	Checking the refrigerant circuit.....	80
8.3	Commissioning procedure .....	80
8.3.1	Commissioning from unit controller .....	81
8.3.1.1	Screed drying function .....	83
8.3.2	NFC Tap Function.....	83
9.	ERP Data.....	<b>84</b>
9.1	AVERAGE climate .....	85
9.2	WARMER climate.....	88
9.3	COLDER climate .....	89
9.4	Additional data .....	90
9.5	General ERP data for hot water storage tanks.....	91



## General information

1.1	General information .....	2
1.1.1	General notes .....	2
1.2	Applied symbols.....	3
1.3	Additional information about safety .....	4
1.4	Important notice.....	5
1.5	Product guide .....	6
1.5.1	Classification of the units .....	6
1.5.1.1	Split system- Indoor unit- <b>airH2O 600S</b> .....	6
1.5.2	Product list.....	6
1.5.2.1	Split system- Indoor unit- <b>airH2O 600S</b> .....	7

## 1.1 General information

### 1.1.1 General notes

© Copyright 2025 Johnson Controls-Hitachi Air Conditioning Spain, S.A.U. – All rights reserved.

No part of this publication may be reproduced, copied, filed or transmitted in any shape or form without the permission of Johnson Controls-Hitachi Air Conditioning Spain, S.A.U.

Within the policy of continuous improvement of its products, Johnson Controls-Hitachi Air Conditioning Spain, S.A.U. reserves the right to make changes at any time without prior notification and without being compelled to introducing them into previously sold products. This document may therefore have been subject to amendments during the life of the product.

Hitachi makes every effort to offer correct, up-to-date documentation. Despite this, printing errors cannot be controlled by Hitachi and are not its responsibility.

As a result, some of the images or data used to illustrate this document may not refer to specific models. No claims will be accepted based on the data, illustrations and descriptions included in this manual.

No type of modification must be made to the equipment without prior, written authorization from the manufacturer.

## 1.2 Applied symbols

During normal heat pump system design work or unit installation, greater attention must be paid in certain situations requiring particular care in order to avoid damage the unit, the installation or the building or property.

Situations endangering the safety of those in the surrounding area or to the unit itself are clearly indicated in this manual.

Special symbols are used to clearly identify these situations.

Pay close attention to these symbols and to the messages following them, as your safety and that of others depends on it.

### DANGER

- *The text following this symbol contains information and instructions relating directly to your safety in addition to hazards or unsafe practices which could result in severe personal injuries or death.*
- *Not taking these instructions into account could lead to serious, very serious or even fatal injuries to you and others in the proximities of the unit.*

In the texts following the danger symbol you can also find information on safety procedures during unit installation.

### CAUTION

- *The text following this symbol contains information and instructions relating directly to your safety, in addition to hazards or unsafe practices which could result in minor personal injuries or product or property damage.*
- *Not taking these instructions into account could lead to minor injuries to you and others.*
- *Not taking these instructions into account could lead to unit damage.*

In the texts following the caution symbol you can also find information on safety procedures during unit installation.

### NOTE

- *The text following this symbol contains information or instructions that may be of use or that requires a more thorough explanation.*
- *Instructions regarding inspections to be made on unit parts or systems may also be included.*

## 1.3 Additional information about safety



### DANGER

- **DO NOT CONNECT THE POWER SUPPLY TO THE INDOOR UNIT PRIOR TO FILLING THE SPACE HEATING CIRCUIT (AND DHW CIRCUIT IF IT WAS THE CASE) WITH WATER AND CHECKING WATER PRESSURE AND THE TOTAL ABSENCE OF ANY WATER LEAKAGE.**
- **Do not pour water over the indoor unit electrical parts. If the electrical components are in contact with water a serious electrical shock will take place.**
- **Do not touch or adjust the safety devices inside the air to water heat pump. If these devices are touched or adjusted, a serious accident can take place.**
- **Do not open the service cover or access inside the air to water heat pump without disconnecting the main power supply.**
- **In case of fire Turn OFF the main switch, put out the fire at once and contact your service contractor.**
- **It must ensure that the air to water heat pump cannot operate accidentally without water neither with air inside hydraulic system.**



### CAUTION

- *Do not use any sprays such as insecticide, lacquer, hair spray or other flammable gases within approximately one meter from the system.*
- *If installation circuit breaker or the unit fuse is often activated, stop the system and contact your service contractor.*
- *Do not make service or inspections tasks by yourself. This work must be performed by a qualified service person.*
- *This appliance must be used only by adult and capable people, having received the technical information or instructions to handle this appliance properly and safely.*
- *Children should be supervised to ensure that they do not play with the appliance.*
- *Do not let any foreign body into the water inlet and outlet piping of the air to water heat pump.*

## 1.4 Important notice

- Verify, in accordance with the manuals which appear in the outdoor and indoor units, that all the information required for the correct installation of the system is included. If this is not the case, contact your distributor.
- Hitachi pursues a policy of continuous improvement in product design and performance. The right is therefore reserved to vary specifications without notice.
- Hitachi cannot anticipate every possible circumstance that might involve a potential hazard.
- This air to water heat pump has been designed for standard water heating for human beings only. Do not use this for other purposes such as for drying clothes, heating foods or for any other heating process (except swimming pool).
- No part of this manual may be reproduced without written permission.
- If you have any questions, contact your service contractor of Hitachi.
- Check and make sure that the explanations of each part of this manual correspond to your air to water heat pump model.
- Refer to the models codification to confirm the main characteristics of your system.
- Signal words (NOTE, DANGER and CAUTION) are used to identify levels of hazard seriousness. Definitions for identifying hazard levels are provided in initial pages of this document.
- The operation modes of these units are controlled by the unit controller.
- This manual should be considered as a permanent part of the air to water heat pump. It gives a common description of and information for this air to water heat pump which you operate as well as for other models.
- Keep the water temperature of the system above the freezing temperature.

## 1.5 Product guide

### 1.5.1 Classification of the units

#### 1.5.1.1 Split system - Indoor unit - airH2O 600S

Unit type: **airH2O 600S** (Split system - Single water module (Indoor unit) - Medium/Low temperature)

Position-separating hyphen (fixed)

Compressor power of the combined outdoor unit (HP): 1.5, 2.0, 2.5, 3.0, 4.0, 5.0, 6.0, 8.0, 10.0

N: R410A refrigerant

R: R32 refrigerant

3: series

Made in Europe

RWM	-	X.X	(X)	3	E
-----	---	-----	-----	---	---

### 1.5.2 Product list

Icons between brackets mean possible extra operations to the factory-supplied operations (additional accessories, field-supplied accessories or systems can be needed).



Heating operation



Swimming pool application



Additional heater (electrical heater accessory or boiler)



Cooling operation



Domestic Hot Water (DHW)



Solar combination

## 1.5.2.1 Split system - Indoor unit - airH2O 600S

~ 230V 50Hz	3N~ 400V 50Hz	
RWM-1.5R3E	RWM-1.5R3E	
RWM-2.0R3E	RWM-2.0R3E	
RWM-2.5R3E	RWM-2.5R3E	
RWM-3.0R3E	RWM-3.0R3E	
RWM-3.5R3E	RWM-3.5R3E	
RWM-4.0R3E	RWM-4.0R3E	
RWM-5.0R3E	RWM-5.0R3E	
RWM-6.0R3E	RWM-6.0R3E	
-	RWM-8.0N3E	
-	RWM-10.0N3E	

For cooling operation, refer to the Cooling kit accessory for **airH2O 600S** units.





## Name of parts and dimensional data

2.1	<b>airH2O 600S</b> RWM-(1.5-3.5)R3E.....	9
2.2	<b>airH2O 600S</b> RWM-(3.5-6.0)R3E.....	10
2.3	<b>airH2O 600S</b> RWM-(8.0/10.0)N3E.....	11

## 2.1 airH2O 600S RWM-(1.5-3.5)R3E

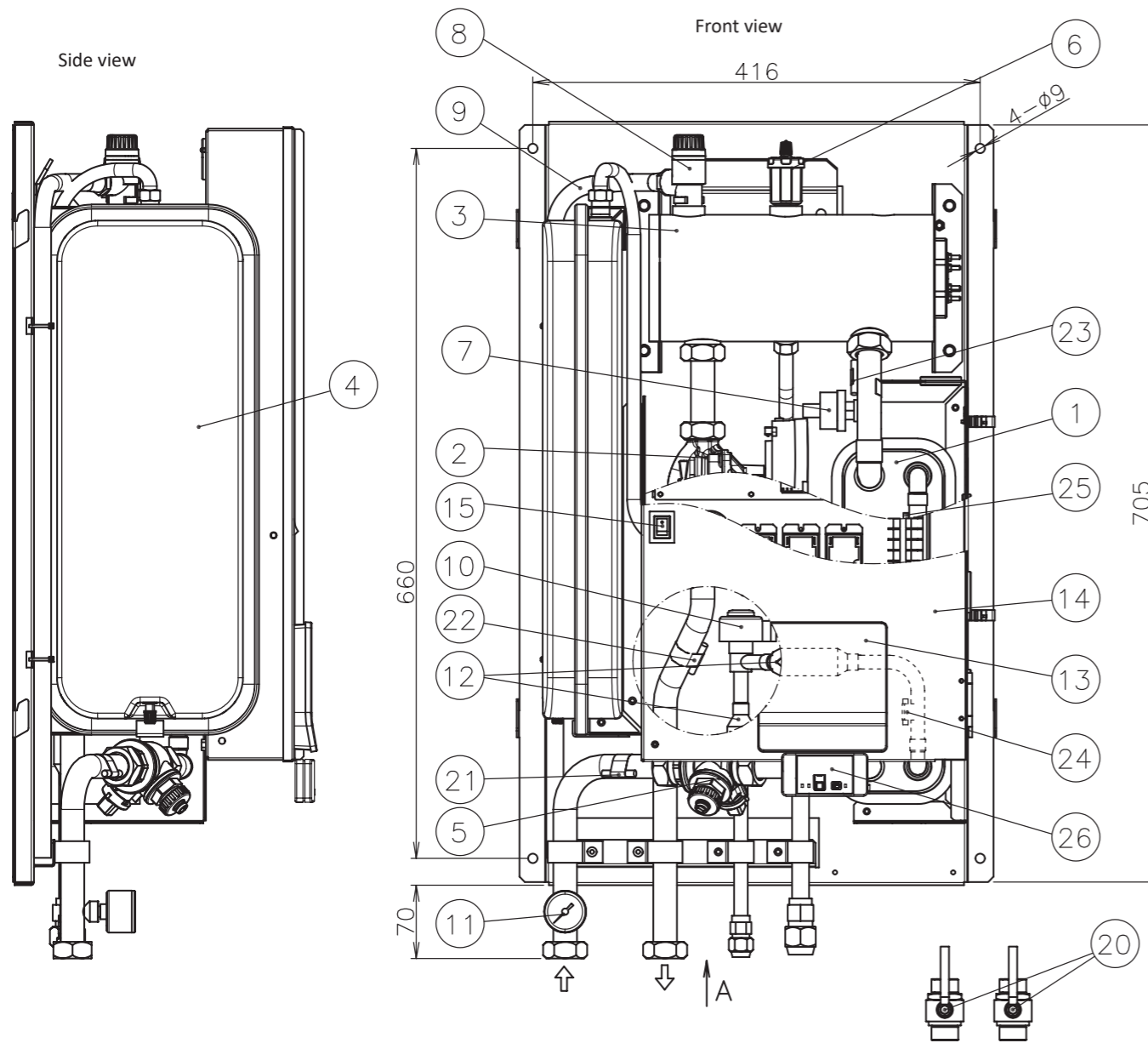

View from A

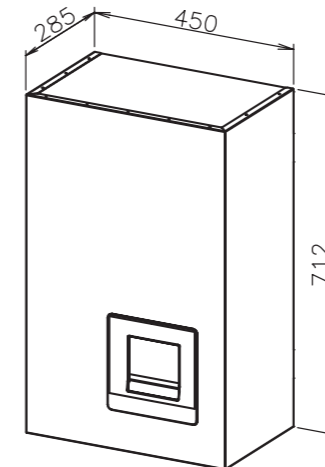
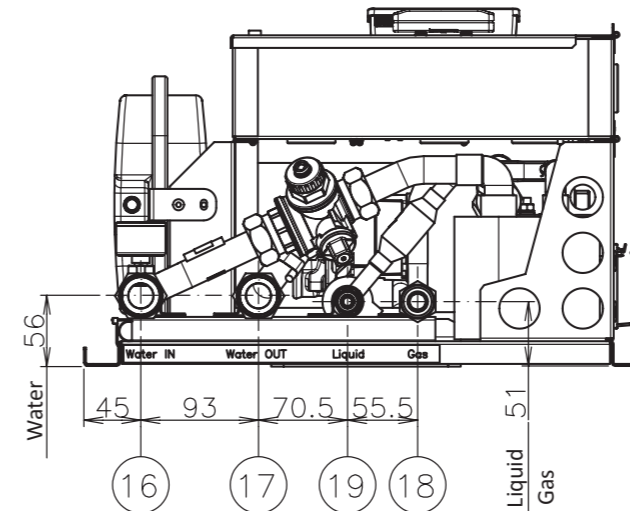

**i** NOTE

← Water flow direction

1. Plate heat exchanger
2. Water pump
3. Electric water heater
4. Expansion vessel 6 l
5. Water strainer
6. Air purger
7. Water pressure sensor
8. Safety valve
9. Drain pipe for safety valve
10. Expansion valve
11. Manometer
12. Refrigerant strainer (x2)
13. Unit controller
14. Electrical box
15. Switch for DHW emergency operation
16. Water inlet pipe connection - G 1" female
17. Water outlet pipe connection - G 1" female
18. Refrigerant gas pipe connection:  $\varnothing$  12.7 mm (1/2")
19. Refrigerant liquid pipe connection -  $\varnothing$  6.35 mm (1/4")
20. Shut-down valve (Factory-supplied accessory)
21. Thermistor (Water inlet pipe)
22. Thermistor (Water outlet pipe)
23. Thermistor (Water outlet PHEX)
24. Thermistor (Liquid refrigerant pipe)
25. Thermistor (Gas refrigerant pipe)
26. IOT Gateway

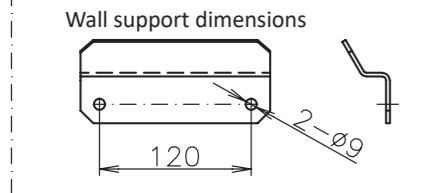

XEKS2067\_r1

Units in mm

## 2.2 airH2O 600S RWM-(3.5-6.0)R3E

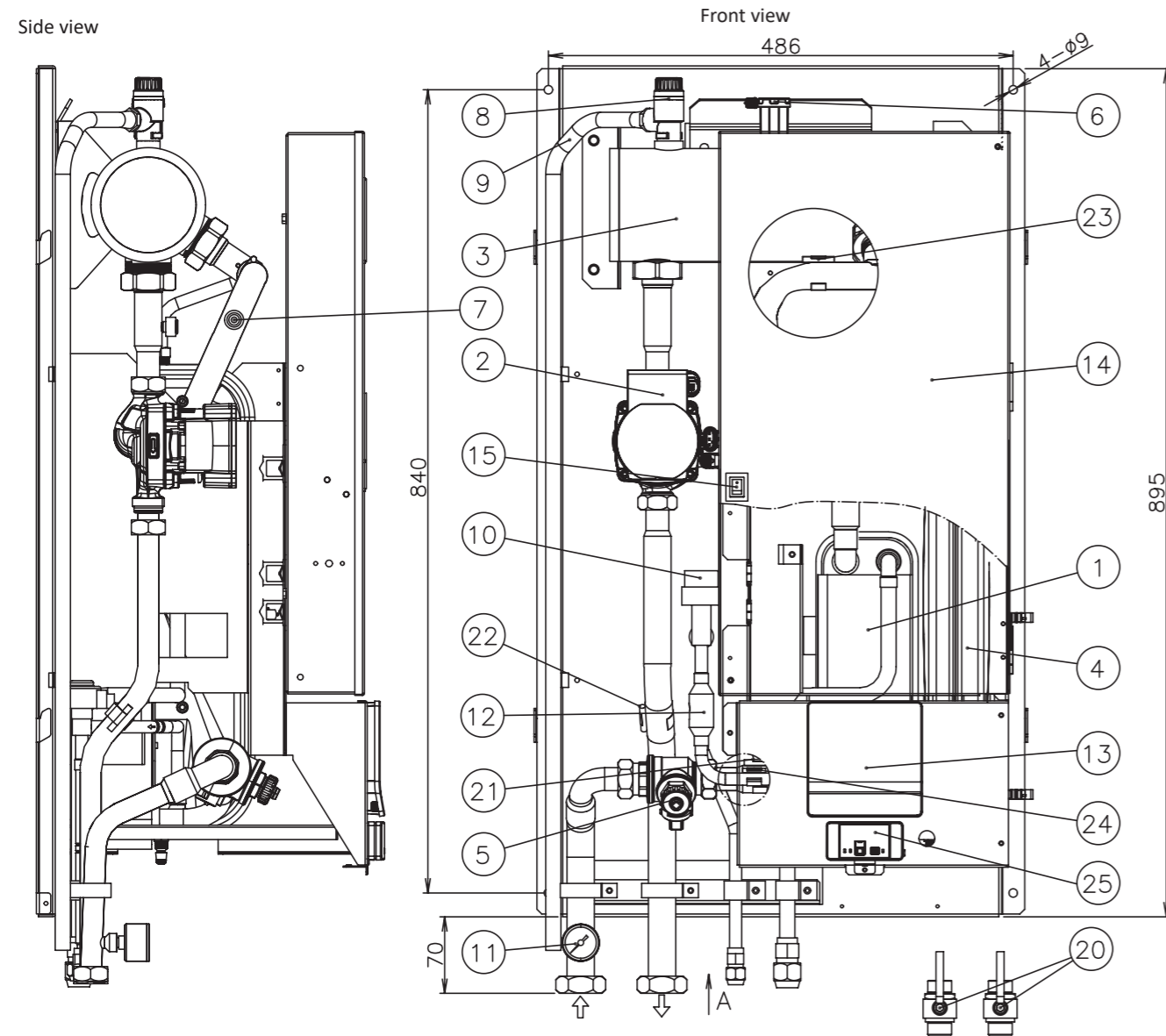

1. Plate heat exchanger
2. Water pump
3. Electric water heater
4. Expansion vessel 6 l
5. Water strainer
6. Air purger
7. Water pressure sensor
8. Safety valve
9. Drain pipe for safety valve
10. Expansion valve
11. Manometer
12. Refrigerant strainer (x2)
13. Unit controller
14. Electrical box
15. Switch for DHW emergency operation
16. Water inlet pipe connection - G 1" female
17. Water outlet pipe connection - G 1" female
18. Refrigerant gas pipe connection:  $\varnothing$  15.88 mm (5/8")
19. Refrigerant liquid pipe connection -  $\varnothing$  6.35 mm (1/4")
20. Shut-down valve (Factory-supplied accessory)
21. Thermistor (Water inlet pipe)
22. Thermistor (Water outlet pipe)
23. Thermistor (Water outlet PHEX)
24. Thermistor (Liquid refrigerant pipe)
25. IOT Gateway

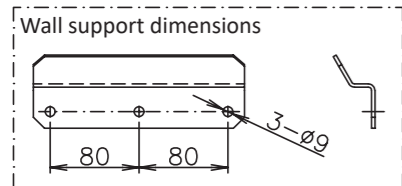

XEKS2068\_r1  
Units in mm

**i** NOTE

← Water flow direction

## 2.3 airH2O 600S RWM-(8.0/10.0)N3E

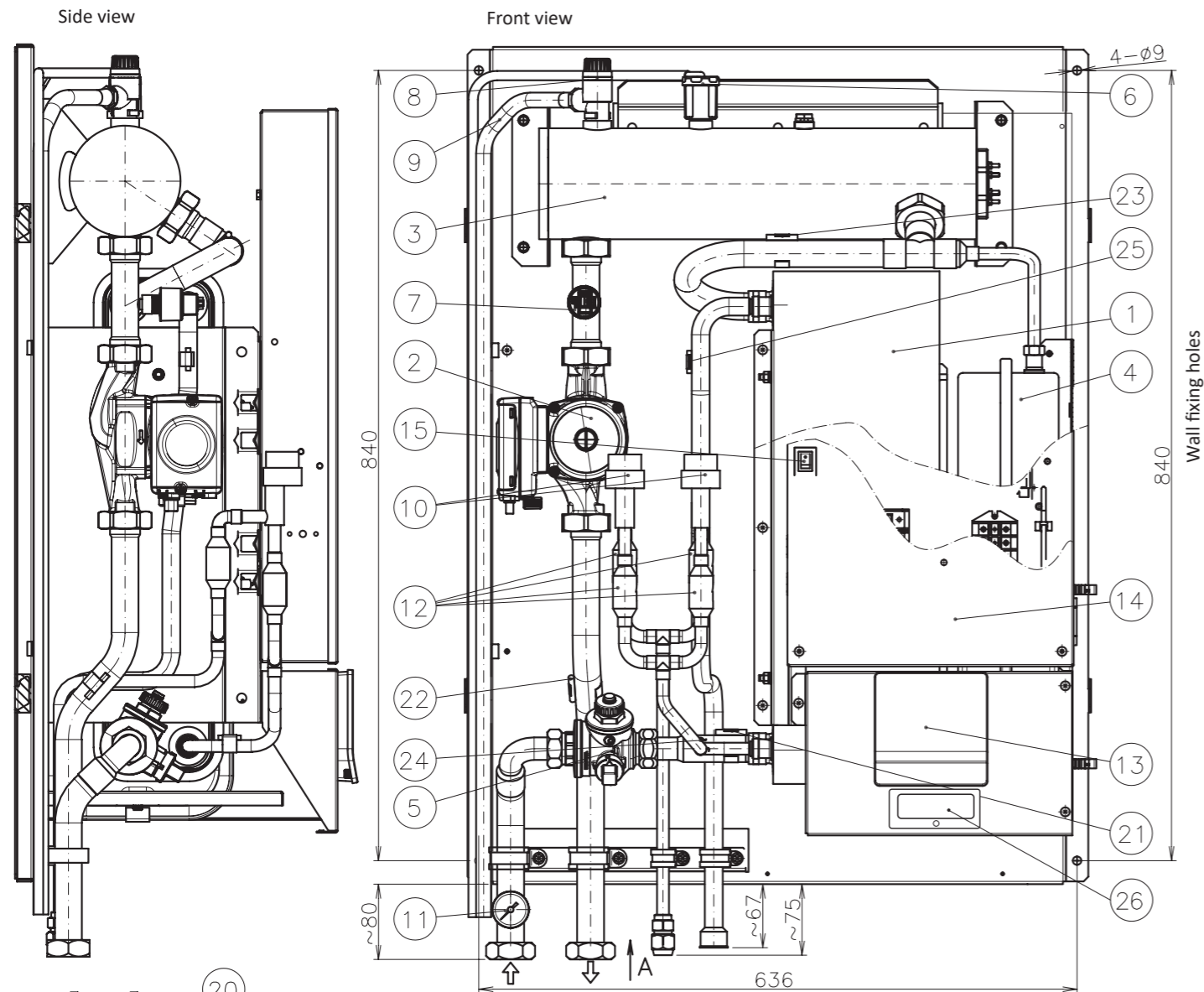

**i** NOTE  
 ↵ Water flow direction

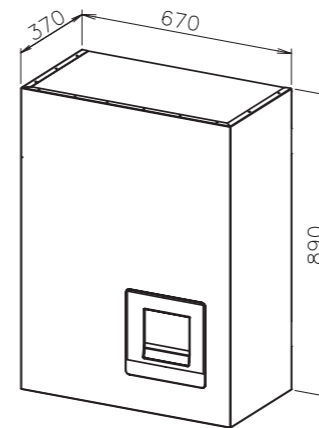

1. Plate heat exchanger
2. Water pump
3. Electric water heater
4. Expansion vessel 10L
5. Water strainer
6. Air purger
7. Water pressure sensor
8. Safety valve
9. Drain pipe for safety valve
10. Expansion valve (x2)
11. Manometer
12. Refrigerant strainer (x4)
13. Unit controller
14. Electrical box
15. Switch for DHW emergency operation
16. Water inlet pipe connection - G 1 1/4" Female
17. Water outlet pipe connection - G 1 1/4" Female
18. Refrigerant gas pipe connection - Ø 25.4 mm (1")
19. Refrigerant liquid pipe connection 8 HP: Ø 9.52 mm (3/8") / 10 HP: Ø 12.7 mm (1/2")
20. Shut-down valve (factory-supplied accessory)
21. Thermistor (Water inlet pipe)
22. Thermistor (Water outlet pipe)
23. Thermistor (Water outlet PHEX)
24. Thermistor (Liquid refrigerant pipe)
25. Thermistor (Gas refrigerant pipe)
26. IOT (Wifi receiver)

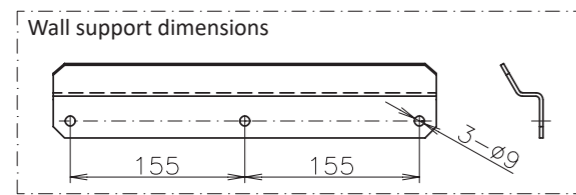

XEKS2014\_r1

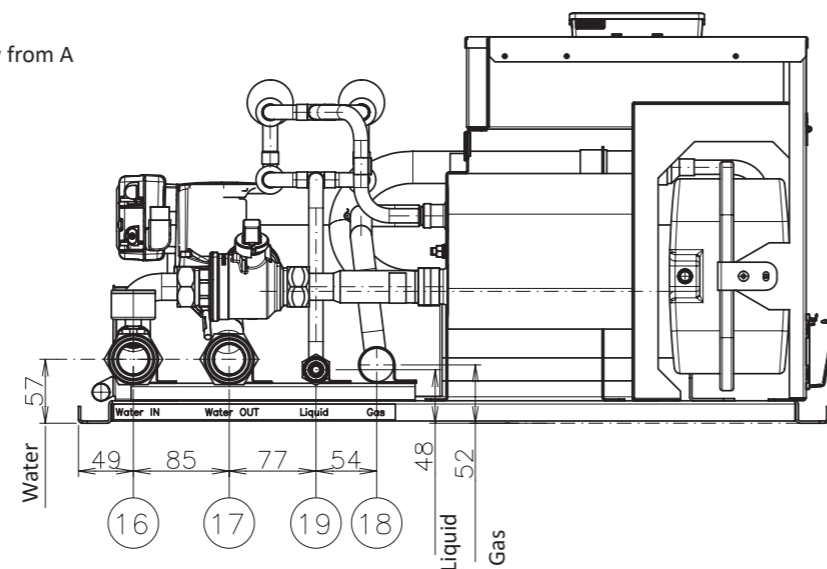

Units: mm



## Electrical data

3.1	Considerations.....	13
3.2	<b>airH2O 600S</b> - RWM-(1.5-6.0)R3E .....	14
3.3	<b>airH2O 600S</b> - RWM-(8.0/10.0)N3E .....	15

## 3.1 Considerations

Key words:

- U: Power supply.
- PH: Phase.
- IPT: Total input power.
- STC: Starting current: Less than maximum current.
- RNC: Running current.
- MC: Maximum current.

### NOTE

- *Heating conditions: Inlet/outlet water temperature: 30/35°C; Outdoor ambient temperature (DB/WB): 7/6°C*
- *The compressor data shown in the tables below are based on a combined capacity of 100% of the power supplied.*
- *The “Maximum current” shown in the above table is the maximum total unit running current at the following conditions:*
  - » *Supply voltage: 90% of the rated voltage.*
  - » *Unit capacity: 100% at maximum operating conditions.*
- *The power supply cables must be sized to cover this maximum current value.*
- *Specifications in these tables are subject to change without notice in order that Hitachi may bring the latest innovations to their customers.*
- *Please refer to the general information, cautions and notes regarding protective devices (CB, ELB) throughout the “**Electrical and control settings**” chapter.*

## 3.2 airH2O 600S - RWM-(1.5-6.0)R3E

Model	Power supply	Applicable voltage		Operation mode	RNC (A)	IPT (kW)	MC (A)	Max. IPT (kW)
		U max. (V)	U min. (V)					
RWM-(1.5-3.0)R3E	~ 230V 50Hz	253	207	Without electric heater	0.6	0.06	0.6	0.06
				With electric heater	13.6	3.06	13.7	3.06
				With DHW tank heater	13.6	3.06	13.7	3.06
				With electric and DHW tank heaters	26.7	6.06	26.7	6.06
	3N~ 400V 50Hz	440	360	Without electric heater	0.6	0.06	0.6	0.06
				With electric heater	4.4	3.06	5.0	3.06
				With DHW tank heater	4.4	3.06	13.7	3.06
				With electric and DHW tank heaters	8.7	6.06	18	6.06
RWM-(3.5-6.0)R3E	~ 230V 50Hz	253	207	Without electric heater	0.6	0.08	0.7	0.08
				With electric heater	26.7	6.08	26.7	6.08
				With DHW tank heater	13.6	3.08	13.7	3.08
				With electric and DHW tank heaters	39.7	9.08	39.8	9.08
	3N~ 400V 50Hz	440	360	Without electric heater	0.6	0.08	0.7	0.08
				With electric heater	8.8	6.08	9.3	6.08
				With DHW tank heater	4.4	3.08	13.7	3.08
				With electric and DHW tank heaters	13.1	9.08	22.4	9.08

The data corresponding to DHW tank heater is calculated in combination with the domestic hot water tank accessory "DHWT-(200/300)S-3.0H2E".

## 3.3 airH2O 600S - RWM-(8.0/10.0)N3E

Model	Power supply	Applicable voltage		Operation mode	RNC (A)	IPT (kW)	MC (A)	Max. IPT (kW)
		U max. (V)	U min. (V)					
RWM-8.0N3E	3N~ 400V 50Hz	440	360	Without electric heater	1.1	0.14	1.16	0.14
				With electric heater	13.2	9.14	14.2	9.14
				With DHW tank heater	4.5	3.14	14.2	3.14
				With electric and DHW tank heaters	17.5	12.14	27.2	12.14
RWM-10.0N3E	3N~ 400V 50Hz	440	360	Without electric heater	1.1	0.14	1.16	0.14
				With electric heater	13.2	9.14	14.2	9.14
				With DHW tank heater	4.5	3.14	14.2	3.14
				With electric and DHW tank heaters	17.5	12.14	27.2	12.14

The data corresponding to DHW tank heater is calculated in combination with the domestic hot water tank accessory "DHWT-(200/300)S-3.0H2E".





## Working range

4.1	Power supply working range .....	17
4.2	Temperature working range .....	17
4.2.1	Space heating .....	17
4.2.2	DHW .....	19
4.2.3	Swimming pool heating .....	20
4.2.4	Space cooling (Necessary cooling kit) .....	21
4.3	Hydraulic working range .....	22
4.3.1	Hydraulic data .....	22
4.3.2	Pump performance curves .....	23

## 4.1 Power supply working range

### ◆ Nominal power supply

- Single phase: ~ 230V 50Hz
- Three phase: 3N~ 400V 50Hz

### ◆ Operating voltage

Between 90 and 110% of the nominal voltage.

### ◆ Voltage imbalance for nominal power supply 3N~ 400V 50Hz

Up to 3% of each phase, measured at the main terminal of the outdoor unit.

### ◆ Starting voltage

Always higher than 85% of the nominal voltage.

## 4.2 Temperature working range

MODEL	1.5 - 10.0 HP
Water temperature	Refer to the graphics for each case
Indoor ambient temperature	5~30

### 4.2.1 Space heating

#### ◆ Split system - airH2O 600S (1.5- 3.0 HP)

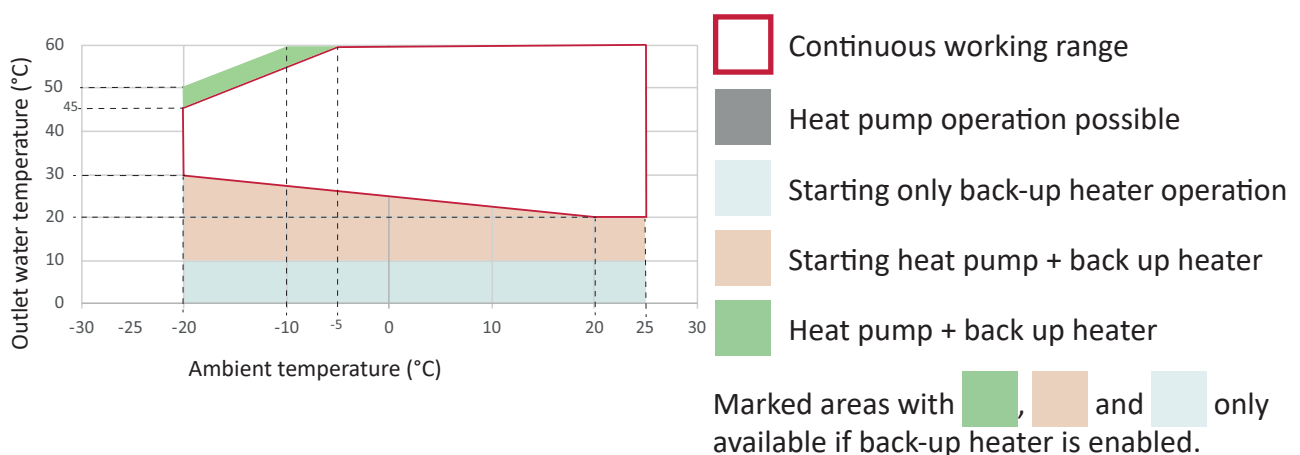

## ◆ Split system - airH2O 600S (3.5- 6.0 HP)

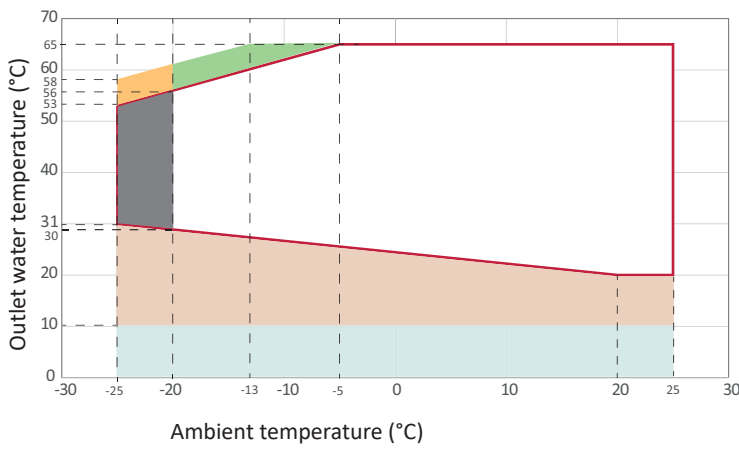

- Continuous working range
  - Heat pump operation possible
  - Starting only back-up heater operation
  - Starting heat pump + back up heater
  - Heat pump + back up heater operation possible
  - Heat pump + back up heater
- Marked areas with , ,  and  only available if back-up heater is enabled.

## ◆ Split system - airH2O 600S (8.0/10.0 HP)

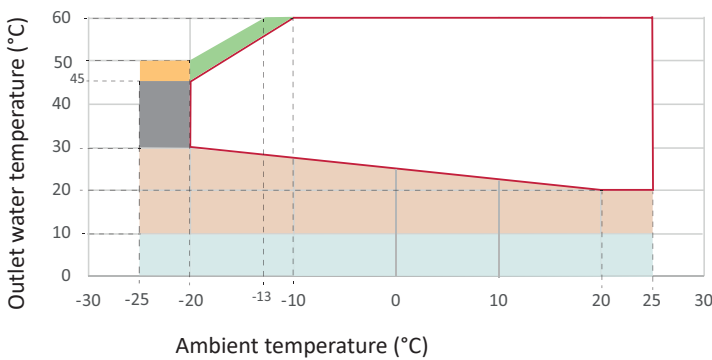

- Continuous working range
  - Heat pump operation possible
  - Starting heat pump + back up heater
  - Starting only back-up heater operation
- Marked areas with  and  only available if back-up heater is enabled.

## 4.2.2 DHW

### ◆ Split system - airH2O 600S (1.5-3.0 HP)

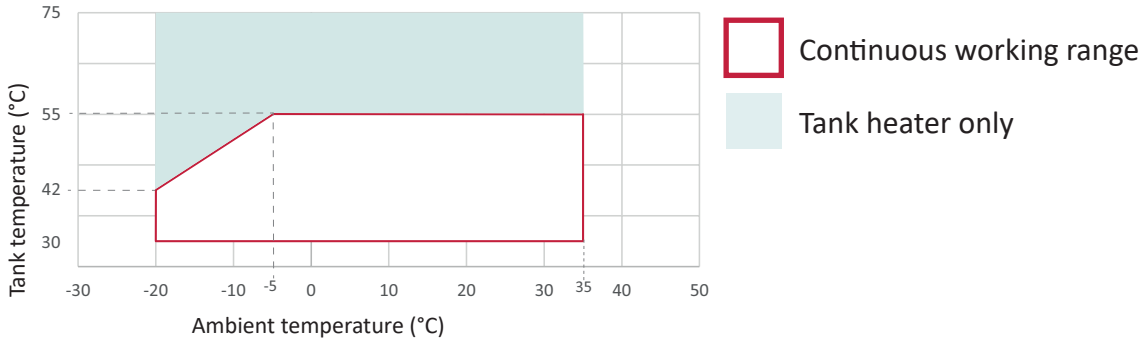

#### **i** NOTE

In case of heating up the DHW tank with an outdoor ambient temperature lower than  $-5^{\circ}\text{C}$  and without using the DHW electrical heater, the setting temperature will change automatically in order to not exceed the maximum value in the specified continuous working range.

### ◆ Split system - airH2O 600S (3.5-6.0 HP)

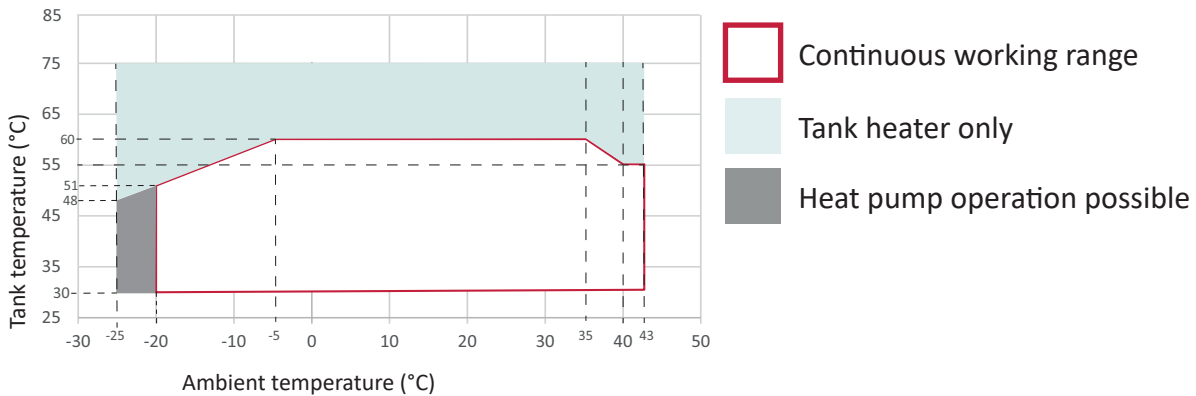

#### **i** NOTE

In case of heating up the DHW tank with an outdoor ambient temperature lower than  $-10^{\circ}\text{C}$  and without using the DHW electrical heater, the setting temperature will change automatically in order to not exceed the maximum value in the specified continuous working range.

## ◆ Split system - airH2O 600S (8.0/10.0 HP)

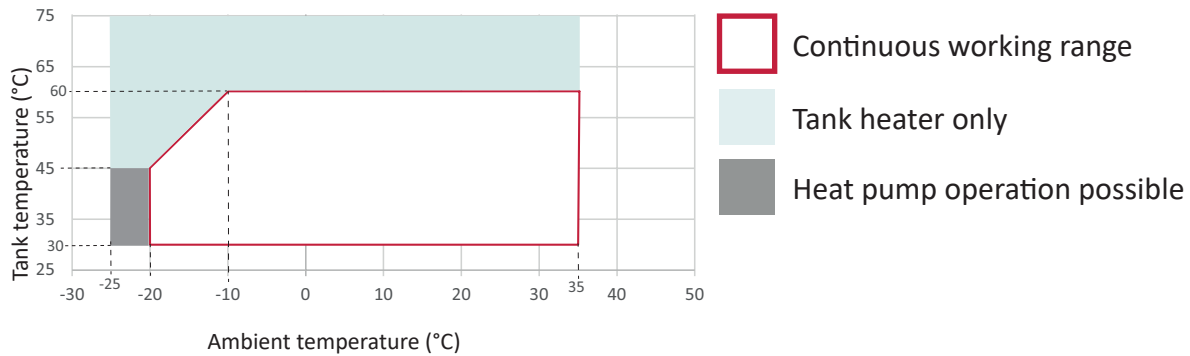

### **i** NOTE

In case of heating up the DHW tank with an outdoor ambient temperature lower than  $-10^{\circ}\text{C}$  and without using the DHW electrical heater, the setting temperature will change automatically in order to not exceed the maximum value in the specified continuous working range.

## 4.2.3 Swimming pool heating

### ◆ Split system - airH2O 600S (1.5-3.0 HP)

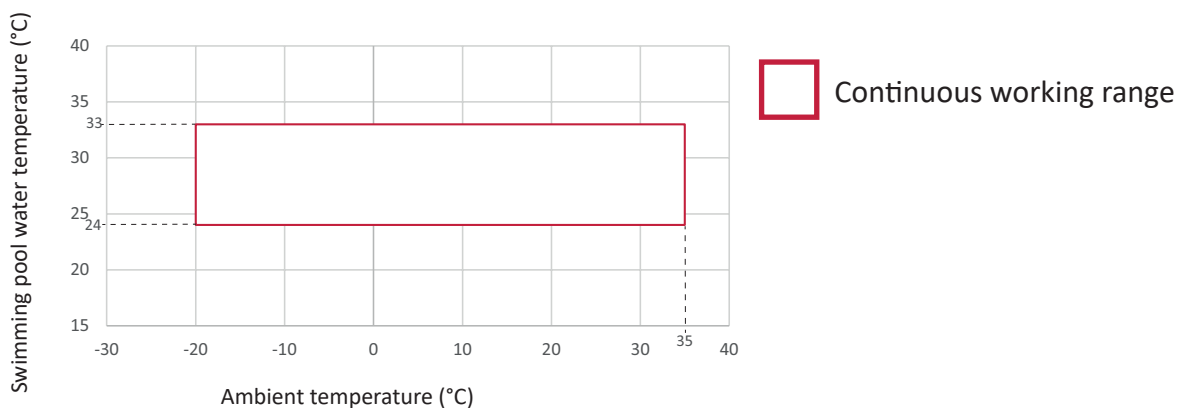

### ◆ Split system - airH2O 600S (3.5-6.0 HP)

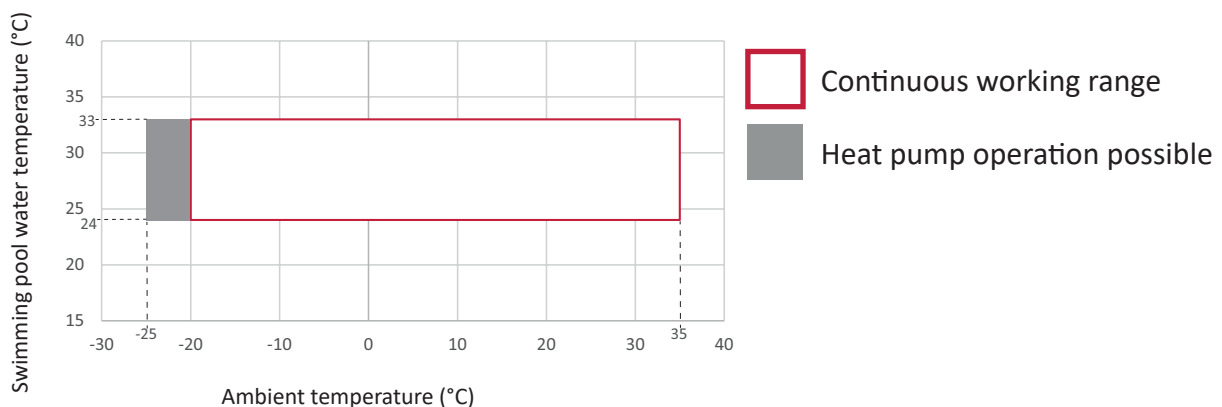

## ◆ Split system - airH2O 600S (8.0/10.0 HP)

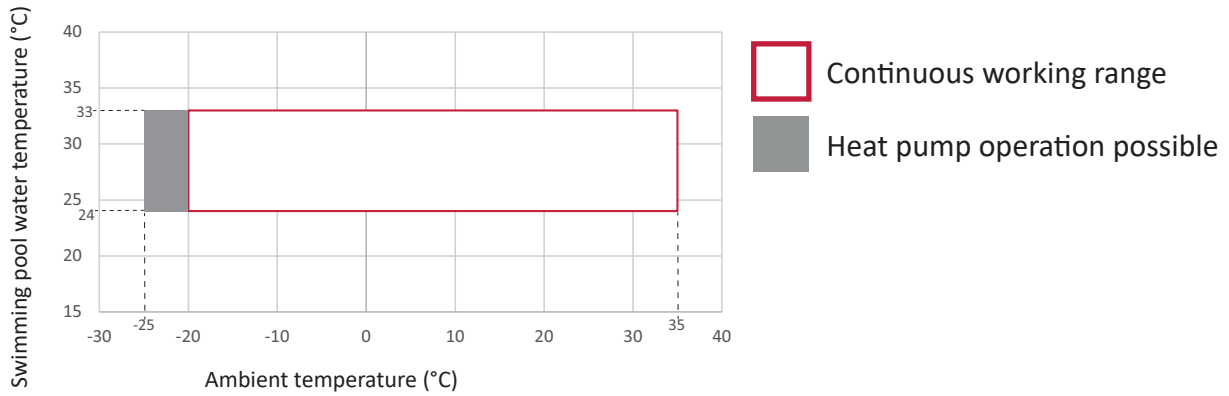

## 4.2.4 Space cooling (Necessary cooling kit)

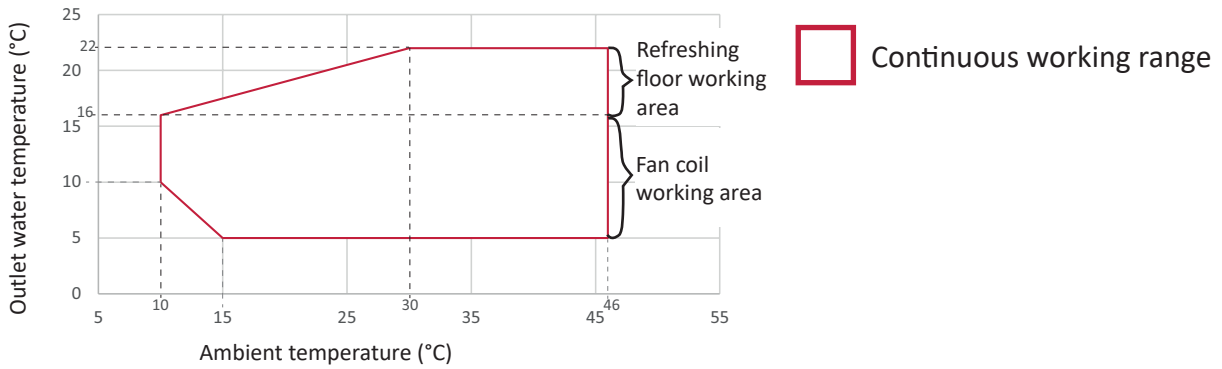

## 4.3 Hydraulic working range

### 4.3.1 Hydraulic data

Model		1.5 HP	2.0 HP	2.5 HP	3.0 HP
Minimum water flow rate (*1)	m <sup>3</sup> /h	0.5	0.5	0.6	0.6
Maximum water flow rate (*1)	m <sup>3</sup> /h	2.1	2.1	2.5	2.5
Minimum installation water volume (*2)	l	28	28	28	28
Minimum allowable water pressure	MPa	0.1	0.1	0.1	0.1
Maximum allowable water pressure	MPa	0.3	0.3	0.3	0.3

Model		3.5 HP	4.0 HP	5.0 HP	6.0 HP
Minimum water flow rate (*1)	m <sup>3</sup> /h	1.0	1.0	1.1	1.2
Maximum water flow rate (*1)	m <sup>3</sup> /h	2.7	2.7	2.8	2.8
Minimum installation water volume (*2)	l	50	50	55	55
Minimum allowable water pressure	MPa	0.1	0.1	0.1	0.1
Maximum allowable water pressure	MPa	0.3	0.3	0.3	0.3

Model		8.0 HP	10.0 HP
Minimum water flow rate (*1)	m <sup>3</sup> /h	2.0	2.2
Maximum water flow rate (*1)	m <sup>3</sup> /h	4.5	4.6
Minimum installation water volume (*2)	l	76	79
Minimum allowable water pressure	MPa	0.1	0.1
Maximum allowable water pressure	MPa	0.3	0.3

(\*1): Values calculated based on the following conditions: Water inlet/outlet temperature: 30/35°C, Outdoor ambient temperature: (DB/WB): 7/6°C.

(\*2): Values calculated with an ON/OFF temperature differential value of 4°C.

## 4.3.2 Pump performance curves

### **i** NOTE

If a water flow rate is selected out of the working range of the unit, it can cause malfunction on the unit. Please, try to operate the pump within the minimum and maximum water flow of the indoor unit.

1.5 HP - 2.0 HP

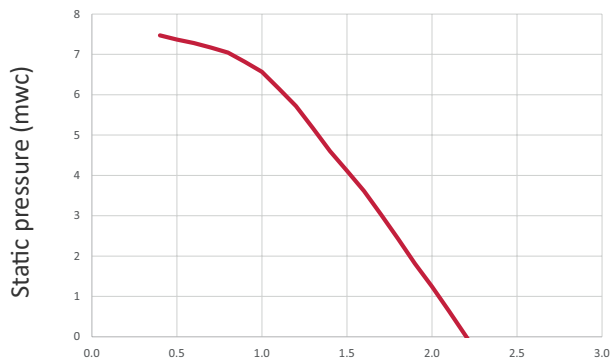

Water flow (m³/h)

2.5 HP - 3.0 HP

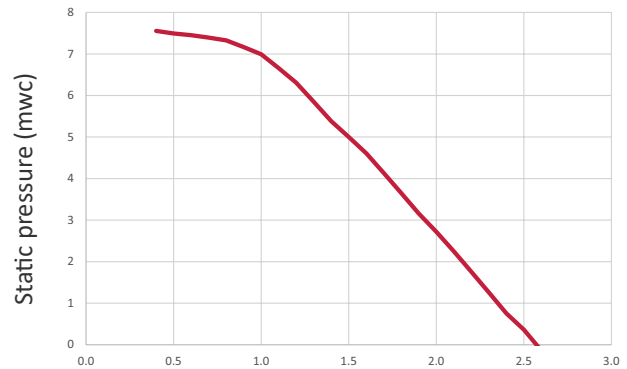

Water flow (m³/h)

3.5 HP

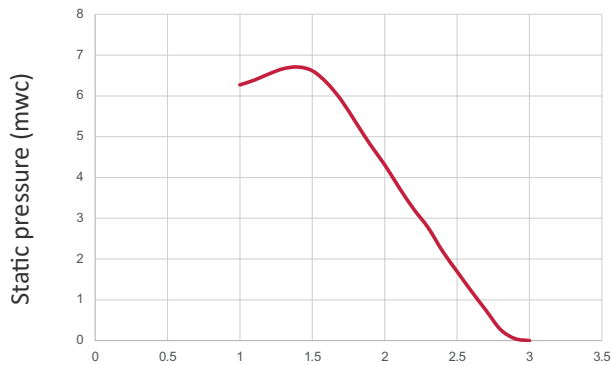

Water flow (m³/h)

4.0 HP

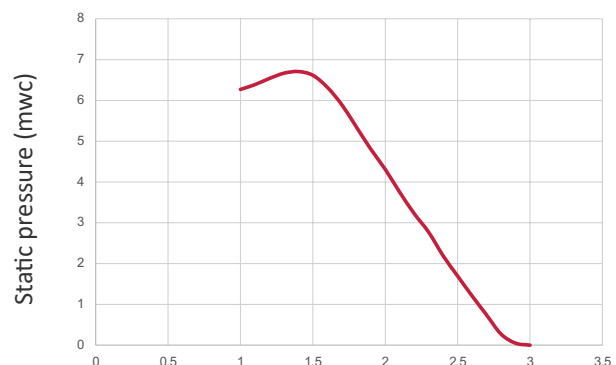

Water flow (m³/h)



5.0 HP

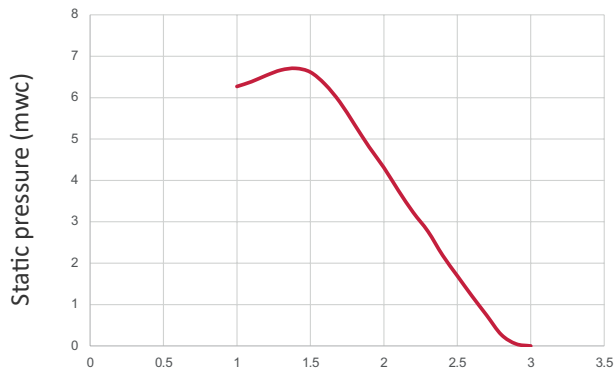

Water flow (m³/h)

6.0 HP

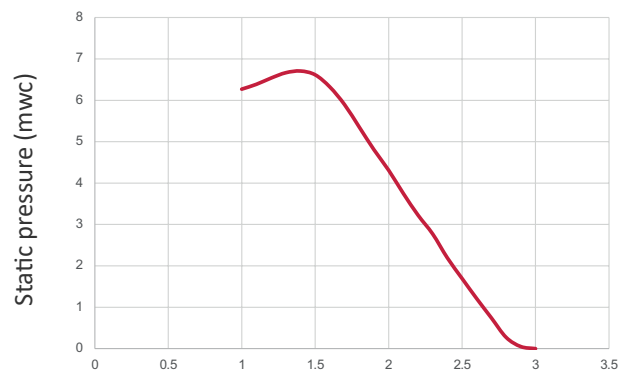

Water flow (m³/h)

8.0 HP

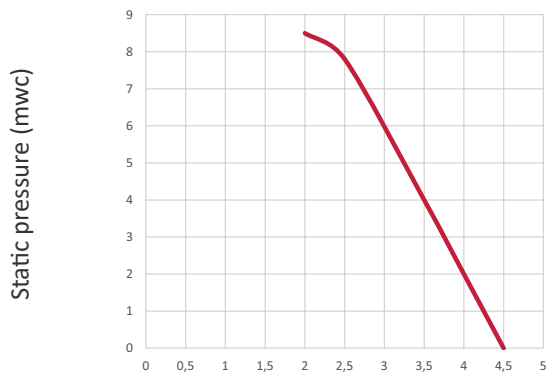

Water flow (m³/h)

10.0 HP

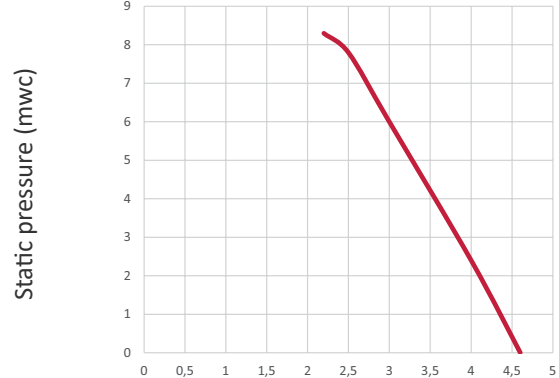

Water flow (m³/h)



## Refrigerant and water piping

5.1	General notes before performing piping work .....	26
5.2	R410A Refrigerant circuit .....	27
5.3	Refrigerant circuit .....	28
5.3.1	General notes R32 refrigerant.....	28
5.4	Refrigerant piping .....	28
5.4.1	Refrigerant piping size .....	28
5.4.2	Refrigerant piping length between indoor unit and outdoor unit (for R32 units) .....	29
5.4.2.1	Minimum floor area for R32 units .....	32
5.4.3	Refrigerant piping length between indoor unit and outdoor unit (R410A units) .....	36
5.5	Refrigerant charge .....	37
5.5.1	Refrigerant charge amount .....	37
5.5.1.1	Refrigerant charge before shipment ( $W_0$ (kg)).....	37
5.6	Water piping .....	37
5.6.1	Water piping length .....	37
5.6.2	Water piping size .....	37
5.6.3	Water quality for primary (space heating / cooling) and secondary (DHW) circuit.....	38
5.6.3.1	Water filling .....	39
5.6.4	Requirements and recommendations for the hydraulic circuit.....	41
5.6.5	Water flow control.....	43
5.7	Space heating and DHW .....	43
5.7.5.1	Additional hydraulic necessary elements for space heating ...	43
5.7.5.2	Additional hydraulic optional elements (For DHW).....	46

## 5.1 General notes before performing piping work

- Prepare locally-supplied copper pipes.
- Select the piping size with the correct thickness and correct material able to withstand sufficient pressure.
- Select clean copper pipes. Make sure that there is no dust or moisture inside the pipes. Blow the inside of the pipes with oxygen free nitrogen to remove any dust and foreign materials before connecting them.

### NOTE

*A system with no moisture or oil contamination will give maximum performance and lifecycle compared to that of a poorly prepared system. Take particular care to ensure that all copper piping is clean and dry internally.*

- Cap the end of the pipe when pipe is to be inserted through a wall hole.
- Do not put pipes on the ground directly without a cap or vinyl tape at the end of the pipe.

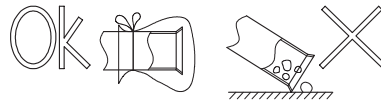

- If piping installation is not completed until next day or over a longer period of time, braze off the ends of the piping and charge with oxygen free nitrogen through a Schrader valve type access fitting to prevent moisture and particle contamination.
- It is advisable to insulate the water pipes, joints and connections in order to avoid heat loss and dew condensation on the surface of the pipes or accidental injuries due to excessive heat on piping surfaces.
- Do not use insulation material that contains  $\text{NH}_3$ , as it can damage copper pipe material and become a source of future leakage.
- It is recommended to use flexible joints for the water piping inlet and outlet in order to avoid vibration transmission.
- Refrigerant circuit and Water circuit must be performed and inspected by a licensed technician and must comply with all relevant European and national regulations.
- Proper water pipe inspection should be performed after piping work to assure there is no water leakage in the space heating circuit.

## 5.2 R410A Refrigerant circuit

### ◆ Precautions in the event of gas refrigerant leaks

The installers and those responsible for drafting the specifications are obliged to comply with local safety codes and regulations in the case of refrigerant leakage.

#### CAUTION

- Check for refrigerant leakage in detail. If a large refrigerant leakage occurred, it would cause difficulty with breathing or harmful gases would occur if a fire were in the room.
- If the flare nut is tightened too hard, it may crack over time and cause refrigerant leakage.

### ◆ Maximum permitted concentration of HFCs

The refrigerant R410A (charged in the outdoor unit) is an incombustible and non-toxic gas. However, if leakage occurs and gas fills a room, it may cause suffocation.

The maximum permissible concentration of HFC gas according to EN378-1 is:

Refrigerant	Maximum permissible concentration (kg/m <sup>3</sup> )
R410A	0.44

The minimum volume of a closed room where the system is installed to avoid suffocation in case of leakage is:

System combination	Minimum volume (m <sup>3</sup> )
8 HP	11.4
10 HP	12.1

The formula used for the calculation of the maximum allowed refrigerant concentration in case of refrigerant leakage is the following:

R	R: Total quantity of refrigerant charged (kg)
— = C	V: Room volume (m <sup>3</sup> )
V	C: Refrigerant concentration

If the room volume is below the minimum value, some effective measure must be taken account after installing to prevent suffocation in case of leakage.

## 5.3 Refrigerant circuit

### 5.3.1 General notes R32 refrigerant



This appliance is filled with R32, an odourless flammable refrigerant gas with low burning velocity (A2L class pursuant to ISO 817). If the refrigerant is leaked, there is a possibility of ignition if it enters in contact with an external ignition source.

**A2L** Make sure that unit installation and refrigerant piping installation comply with applicable legislation in each country. Also, in Europe, EN378 must be complied, as it is the applicable standard.

## 5.4 Refrigerant piping

### 5.4.1 Refrigerant piping size

Piping connection size of outdoor unit and indoor unit:

Model (HP)	Piping length	Outdoor unit		Refrigerant pipe		Indoor Unit	
		Pipe connection size		(Between outdoor unit and indoor unit)		Pipe connection size	
		Gas pipe mm (in.)	Liquid pipe mm (in.)	Gas pipe mm (in.)	Liquid pipe mm (in.)	Gas pipe mm (in.)	Liquid pipe mm (in.)
1.5	3~50 m	∅ 12.7 (1/2)	∅ 6.35 (1/4)	∅ 12.7 (1/2)	∅ 6.35 (1/4)	∅ 12.7 (1/2)	∅ 6.35 (1/4)
2	3~50 m	∅ 12.7 (1/2)	∅ 6.35 (1/4)	∅ 12.7 (1/2)	∅ 6.35 (1/4)	∅ 12.7 (1/2)	∅ 6.35 (1/4)
2.5	3~30 m	∅ 12.7 (1/2)	∅ 6.35 (1/4)	∅ 12.7 (1/2)	∅ 6.35 (1/4)	∅ 12.7 (1/2)	∅ 6.35 (1/4)
3	3~30 m	∅ 12.7 (1/2)	∅ 6.35 (1/4)	∅ 12.7 (1/2)	∅ 6.35 (1/4)	∅ 12.7 (1/2)	∅ 6.35 (1/4)
2.5	30~40 m	∅ 12.7 (1/2)	∅ 6.35 (1/4)	∅ 15.88 (5/8)	∅ 9.52 (3/8)	∅ 12.7 (1/2)	∅ 6.35 (1/4)
3	30~40 m	∅ 12.7 (1/2)	∅ 6.35 (1/4)	∅ 15.88 (5/8)	∅ 9.52 (3/8)	∅ 12.7 (1/2)	∅ 6.35 (1/4)
3.5-6	5~30 m	∅ 15.88 (5/8)	∅ 6.35 (1/4)	∅ 12.7 (1/2)* or ∅ 15.88 (5/8)	∅ 6.35 (1/4)	∅ 15.88 (5/8)	∅ 6.35 (1/4)
3.5-6	30~50 m	∅ 15.88 (5/8)	∅ 6.35 (1/4)	∅ 15.88 (5/8)	∅ 9.52 (3/8)	∅ 15.88 (5/8)	∅ 6.35 (1/4)
8	5~70 m	∅ 25.4 (1)	∅ 9.52 (3/8)	∅ 25.4 (1)	∅ 9.52 (3/8)	∅ 25.4(1")	∅ 9.52 (3/8)
10			∅ 12.7 (1/2)		∅ 12.7 (1/2)		∅ 12.7 (1/2)

\* Only use gas pipe of 12.7 mm (1/2") for heat only units for a piping length from 5 m to 30 m.

## 5.4.2 Refrigerant piping length between indoor unit and outdoor unit (for R32 units)

The unit installation and refrigerant piping should comply with the relevant local and national regulations for the designed refrigerant. Due to R32 refrigerant and depending on final refrigerant charge amount, a minimum floor area for installation must be considered.

- If total refrigerant charge amount <1.84kg, there are no minimum floor area requirements.
- If total refrigerant charge amount ≥1.84kg, there are minimum floor area requirements to be checked.

### ◆ Indoor unit in combination with RAS-1.5-3WHVRP2E

L≤30m		1.5HP	2HP	2.5HP	3HP	
Factory Charge	kg	1.1	1.1	1.2	1.2	
Charge-less piping length	m	10	10	10	10	
Additional Charge needed	g/m	15	15	15	15	
Maximum piping	m	30	30	30	30	
Maximum total refrigerant charge	kg	1.4	1.4	1.5	1.5	
Minimum room area requirement (Amin)	m <sup>2</sup>	No requirement is needed				
Minimum piping length between outdoor unit and indoor unit (Lmin)	m	3(*)	3(*)	3(*)	3(*)	
Maximum height difference between indoor and outdoor unit (H)						
Outdoor unit higher than indoor unit		m	30	30	30	30
Indoor unit higher than outdoor unit		m	20	20	20	20

(\*) In case of a piping length below 5 m (3 m ~ 5 m) remove 150 g of R32 refrigerant.

L>30m		1.5HP	2HP	2.5HP	3HP	
Factory Charge	kg	1.1	1.1	1.2	1.2	
Charge-less piping length	m	10	10	10	10	
Additional Charge needed	g/m	15	15	30	30	
Maximum piping	m	50	50	40	40	
Maximum total refrigerant charge	kg	1.7	1.7	2.1	2.1	
Minimum room area requirement (Amin)	m <sup>2</sup>	No requirement is needed		Check minimum floor area table		
Minimum piping length between outdoor unit and indoor unit (Lmin)	m	3(*)	3(*)	3(*)	3(*)	
Maximum height difference between indoor and outdoor unit (H)						
Outdoor unit higher than indoor unit		m	30	30	30	30
Indoor unit higher than outdoor unit		m	20	20	20	20

(\*) In case of a piping length below 5 m (3 m ~ 5 m) remove 150 g of R32 refrigerant.

## ◆ Indoor unit in combination with RAS-3.5-6WHVRP2E

### Heating only (factory default)

L≤30m		3.5HP	4HP	5HP	6HP
Factory Charge	kg	1.8	1.8	2.1	2.1
Charge-less piping length	m	10(*)	10(*)	10(*)	10(*)
Additional charge needed	g/m	40	40	40	40
Maximum piping length	m	30	30	30	30
Maximum additional refrigerant charge	kg	0.8	0.8	0.8	0.8
Maximum total refrigerant charge	kg	2.6	2.6	2.9	2.9
Minimum room area requirement (Amin)	m <sup>2</sup>	Check minimum floor area table			
Minimum piping length between outdoor unit and indoor unit (Lmin)	m	5	5	5	5
Maximum height difference between indoor and outdoor unit (H)					
Outdoor unit higher than indoor unit	m	30	30	30	30
Indoor unit higher than outdoor unit	m	20	20	20	20

(\*) If maximum Two is limited to 60°C by installer, chargeless length can be increased up to 15m. For distance above 15m, always apply the table, no matter Two limits.

L>30m		3.5HP	4HP	5HP	6HP
Factory Charge	kg	1.8	1.8	2.1	2.1
Charge-less piping length	m	10	10	10	10
Additional charge needed	g/m	45	45	45	45
Maximum piping length	m	50	50	50	50
Maximum additional refrigerant charge	kg	1.8	1.8	1.8	1.8
Maximum total refrigerant charge	kg	3.6	3.6	3.9	3.9
Minimum room area requirement (Amin)	m <sup>2</sup>	Check minimum floor area table			
Minimum piping length between outdoor unit and indoor unit (Lmin)	m	5	5	5	5
Maximum height difference between indoor and outdoor unit (H)					
Outdoor unit higher than indoor unit	m	30	30	30	30
Indoor unit higher than outdoor unit	m	20	20	20	20

## Reversible models (Cooling and Heating) (charge by installer)

L≤30m		3.5HP	4HP	5HP	6HP
Factory Charge	kg	1.8	1.8	2.1	2.1
Additional charge for reversible models (mandatory by installer)	kg	0.4	0.4	0.4	0.4
Charge-less piping length	m	5	5	5	5
Additional refrigerant charge	g/m	40	40	40	40
Maximum piping length	m	30	30	30	30
Maximum additional charge (kg)	kg	1.4	1.4	1.4	1.4
Maximum total refrigerant charge	kg	3.2	3.2	3.5	3.5
Minimum room area requirement (Amin)	m <sup>2</sup>	Check minimum floor area table			
Minimum piping length between outdoor unit and indoor unit (Lmin)	m	5	5	5	5
Maximum height difference between indoor and outdoor unit (H)					
Outdoor unit higher than indoor unit	m	30	30	30	30
Indoor unit higher than outdoor unit	m	20	20	20	20
L>30m		3.5HP	4HP	5HP	6HP
Factory Charge	kg	1.8	1.8	2.1	2.1
Additional charge for reversible models (mandatory by installer)	kg	0.4	0.4	0.4	0.4
Charge-less piping length	m	5	5	5	5
Additional refrigerant charge	g/m	45	45	45	45
Maximum piping length	m	50	50	50	50
Maximum additional charge (kg)	kg	2.43	2.43	2.43	2.43
Maximum total refrigerant charge	kg	4.2	4.2	4.5	4.5
Minimum room area requirement (Amin)	m <sup>2</sup>	Check minimum floor area table			
Minimum piping length between outdoor unit and indoor unit (Lmin)	m	5	5	5	5
Maximum height difference between indoor and outdoor unit (H)					
Outdoor unit higher than indoor unit	m	30	30	30	30
Indoor unit higher than outdoor unit	m	20	20	20	20



## 5.4.2.1 Minimum floor area for R32 units

Please refer to outdoor unit installation manual for charge calculation.

- 1 Check the refrigerant charge:
  - a. If the refrigerant charge is <1.84 kg, no minimum area is required.
  - b. If the refrigerant charge is >1.84 kg, check the Table 1 for minimum floor area ( $A_{\min}$ ).
- 2 Calculate the room area:
  - a. Check the Table 1 to see the corresponding minimum room area (room A) according to the maximum refrigerant charge ( $m_c$ ) and the installation height ( $h_o$ ).
  - b. In case that the room area is not complying the minimum area requirement, check for an adjacent room (room B).
- 3 Determine total floor area of room A and room B:
  - a. Calculate the area of room B adjacent to the room A.
  - b. Determine the  $A_{\min \text{ total}}$  ( $A_{\min \text{ total}} = \text{Room A} + \text{Room B}$ ) based on the total refrigerant charge ( $m_c$ ) from Table 2.
  - c. The total floor area both room A and room B must exceed  $A_{\min \text{ total}}$ .
- 4 Determine Minimum Venting Opening Area ( $VA_{\min}$ ) for Natural Ventilation
  - ✓ For connected rooms and natural ventilation, the following conditions must be satisfied:
  - ✓ High-Level Openings: Openings located more than 300 mm above the floor will not count towards the required minimum ventilation area ( $A_{\text{nv,min}}$ ).
  - ✓ Low-Level Openings: At least half of the required ventilation area ( $A_{\text{nv,min}}$ ) must be situated below 200 mm from the floor.
  - ✓ Lowest Point of Openings: The base of the lowest openings must be no higher than the release point of the refrigerant and should not exceed 100 mm from the floor.
  - ✓ Permanent Openings: Ventilation openings must be permanent and cannot be sealed.
  - ✓ Connecting Room Openings: Openings that connect rooms must have a height of at least 20 mm between the wall and the floor.
  - ✓ Additional Higher Opening: A second, higher opening is required. This additional opening should be at least 50% of the  $A_{\text{nv,min}}$  and positioned no less than 1.5 meters above the floor.

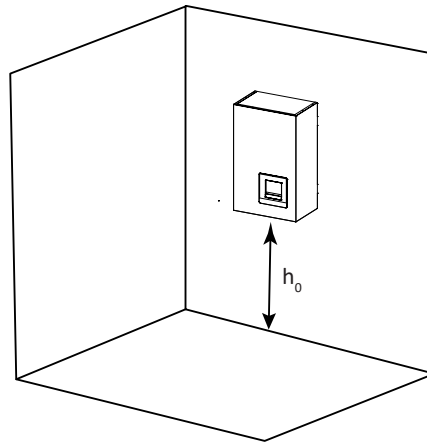

Room A

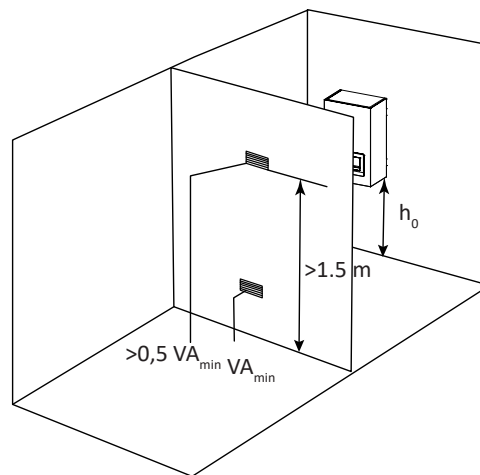

Room A + Room B

**i** NOTE

*In case of not able to proceed with any of option above. Please consider to select other outdoor unit combination option (reduce piping length, monobloc systems, etc...).*

◆ Table 1

$m_c$ (Kg)	Min floor area ( $A_{min}$ ) (m <sup>2</sup> )							
	$h_0$							
	1.2	1.3	1.4	1.5	1.6	1.7	1.8	1.9
1.84	7.20	6.15	5.71	5.33	4.99	4.70	4.44	4.21
2.0	8.51	7.25	6.25	5.79	5.43	5.11	4.82	4.57
2.2	10.30	8.77	7.57	6.59	5.97	5.62	5.31	5.03
2.4	12.26	10.44	9.00	7.84	6.89	6.13	5.79	5.48
2.6	14.38	12.26	10.57	9.21	8.09	7.17	6.39	5.94
2.8	16.68	14.21	12.26	10.68	9.38	8.31	7.41	6.65
3.0	19.15	16.32	14.07	12.26	10.77	9.54	8.51	7.64
3.2	21.79	18.56	16.01	13.94	12.26	10.86	9.68	8.69
3.4	24.6	20.96	18.07	15.74	13.84	12.26	10.93	9.81
3.6	27.58	23.50	20.26	17.65	15.51	13.74	12.26	11.0
3.8	30.72	26.18	22.57	19.66	17.28	15.31	13.66	12.26
4.0	34.04	29.01	25.01	21.79	19.15	16.96	15.13	13.58
4.2	37.53	31.98	27.58	24.02	21.11	18.70	16.68	14.97
4.4	41.19	35.10	30.26	26.36	23.17	20.52	18.31	16.43
4.5	43.09	36.71	31.66	27.58	24.24	21.47	19.15	17.19
4.6	45.02	38.36	33.08	28.81	25.33	22.43	20.01	17.96

◆ Table 2 (Examples)

$m_c$ (Kg)	Minimum opening for natural ventilation $A_{nvmin1}$ (dm <sup>2</sup> ) $h_0=1.3$ m						
	Room A area (m <sup>2</sup> )						
	7	10	13	15	18	20	
1.84	-	-	-	-	-	-	
2.0	0.10	-	-	-	-	-	
2.2	0.67	-	-	-	-	-	
2.4	1.24	0.16	-	-	-	-	
2.6	1.81	0.79	-	-	-	-	
2.8	2.38	1.41	0.41	-	-	-	
3.0	2.95	2.03	1.08	0.43	-	-	
3.2	3.52	2.66	1.74	1.12	0.18	-	
3.4	4.09	3.28	2.41	1.81	0.90	0.30	
3.6	4.66	3.90	3.07	2.50	1.63	1.04	
3.8	5.23	4.53	3.74	3.19	2.35	1.78	
4.0	5.80	5.15	4.40	3.88	3.07	2.52	
4.2	6.37	5.77	5.07	4.57	3.79	3.26	
4.4	6.94	6.40	5.74	5.26	4.51	4.00	
4.5	7.23	6.71	6.07	5.61	4.88	4.37	
4.6	7.51	7.02	6.40	5.95	5.24	4.75	

$m_c$ (Kg)	Minimum opening for natural ventilation $A_{nv,min1}$ (dm <sup>2</sup> ) $h_0=1.5$ m					
	Room A area (m <sup>2</sup> )					
	7	10	13	15	18	20
1.84	-	-	-	-	-	-
2.0	-	-	-	-	-	-
2.2	-	-	-	-	-	-
2.4	0.36	-	-	-	-	-
2.6	0.89	-	-	-	-	-
2.8	1.42	0.27	-	-	-	-
3.0	1.95	0.85	-	-	-	-
3.2	2.48	1.43	0.35	-	-	-
3.4	3.01	2.01	0.97	0.27	-	-
3.6	3.54	2.59	1.59	0.91	-	-
3.8	4.07	3.17	2.21	1.55	0.56	-
4.0	4.60	3.75	2.83	2.19	1.23	0.59
4.2	5.13	4.33	3.44	2.83	1.90	1.28
4.4	5.66	4.91	4.06	3.48	2.57	1.97
4.5	5.93	5.20	4.37	3.80	2.91	2.31
4.6	6.19	5.49	4.68	4.12	3.25	2.66

$m_c$ (Kg)	Minimum opening for natural ventilation $A_{nv,min1}$ (dm <sup>2</sup> ) $h_0=1.7$ m					
	Room A area (m <sup>2</sup> )					
	7	10	13	15	18	20
1.84	-	-	-	-	-	-
2.0	-	-	-	-	-	-
2.2	-	-	-	-	-	-
2.4	-	-	-	-	-	-
2.6	0.08	-	-	-	-	-
2.8	0.58	-	-	-	-	-
3.0	1.08	-	-	-	-	-
3.2	1.57	0.36	-	-	-	-
3.4	2.07	0.90	-	-	-	-
3.6	2.57	1.45	0.29	-	-	-
3.8	3.07	1.99	0.87	0.12	-	-
4.0	3.57	2.54	1.46	0.73	-	-
4.2	4.07	3.08	2.04	1.33	0.26	-
4.4	4.57	3.63	2.62	1.93	0.89	0.19
4.5	4.82	3.90	2.91	2.23	1.20	0.52
4.6	5.07	4.17	3.20	2.54	1.52	0.84

## NOTE

The minimum opening area for natural ventilation between room A and room B is calculated by the following formula:

$$A_{nv,min1} = 1.51 \times (m_c - m_{max}) \times (A_{roomA} / m_{max})^{(1/2)}$$

$$m_{max} = 0.571 \times h_0 \times (A_{roomA})^{(1/2)}$$

Where:

- $A_{nv,min1}$ : minimum opening for natural ventilation between room A and room B, in dm<sup>2</sup>.

- $A_{\text{roomA}}$ : room A area, in  $\text{m}^2$ .
- $m_{\text{max}}$ : the allowable maximum refrigerant charge in the room A, in kg.
- Mark “-” in the above table indicates that the room A is large enough for installation without adjacent room B.
- For intermediate refrigerant charges, room A area and installation height, select the higher charge value, the smaller room area and the lower height value to choose the  $A_{\text{nv,min1}}$ . For example, if the refrigerant charge is 2.9 kg, room A area is  $8 \text{ m}^2$  and the installation height is 1.85 m, then  $A_{\text{nv,min1}} = 1.08 \text{ dm}^2$  according to the table ( $h_0 = 1.7 \text{ m}$ ).

### 5.4.3 Refrigerant piping length between indoor unit and outdoor unit (R410A units)

		8 HP	10HP
Factory charge	kg	5.0	5.3
Charge-less piping length	m	15	15
Additional charge needed	g/m	65	65
Maximum piping	m	70	70
Maximum total refrigerant charge	kg	10.3	12.1
Minimum piping length between outdoor unit and indoor unit (Lmin)	m	5	5
Maximum height difference between indoor and outdoor unit (H)			
Outdoor unit higher than indoor unit	m	30	30
Indoor unit higher than outdoor unit	m	20	20

## 5.5 Refrigerant charge

### 5.5.1 Refrigerant charge amount

The refrigerant is factory charged in the outdoor unit.

#### 5.5.1.1 Refrigerant charge before shipment ( $W_0$ (kg))

Outdoor unit model	Refrigerant	$W_0$ (kg)
RAS-1.5WHVRP2E	R32	1.1
RAS-2WHVRP2E	R32	1.1
RAS-2.5WHVRP2E	R32	1.2
RAS-3WHVRP2E	R32	1.2
RAS-3.5WH(V)RP2E	R32	1.8
RAS-4WH(V)RP2E	R32	1.8
RAS-5WH(V)RP2E	R32	2.1
RAS-6WH(V)RP2E	R32	2.1
RAS-8WHNPE	R410A	5.0
RAS-10WHNPE	R410A	5.3

## 5.6 Water piping

### 5.6.1 Water piping length

Consider the following guidelines when designing the water circuit.

Item	airH2O 600S
Maximum water piping length between indoor unit and DHW tank	10 m
Maximum water piping length between indoor unit and 3-way valve	3 m
Maximum water piping length between 3-way valve and DHW tank	10 m

### 5.6.2 Water piping size

(inches)

Model	Space heating pipes connection		
	Inlet connection	Outlet connection	Shut-off valves
(1.5-3.0)HP	G 1" (female)	G 1" (female)	"G 1" (male) - G 1" (male)"
(3.5-6.0)HP	G 1" (female)	G 1" (female)	G 1" (male) - G 1" (male)
(8/10.0)HP	G 1-1/4" (female)	G 1-1/4" (female)	G 1-1/4" (male) - G 1-1/4" (male)

## 5.6.3 Water quality for primary (space heating / cooling) and secondary (DHW) circuit

### CAUTION

- Water quality must be according to EU council directive 98/83 EC.
- Water should be subjected to filtration or to a softening treatment with chemicals before application as treated water.
- It is also necessary to analyse the quality of water by checking pH, electrical conductivity, ammonia ion content, sulphur content, and others. If the results of the analysis are not good, the use of industrial water would be recommended.
- No antifreeze agent shall be added to the water circuit in a split systems.
- To avoid deposits of scale on the heat exchangers surface it is mandatory to ensure a high water quality with low levels of  $\text{CaCO}_3$ .

Before water filling, sludge removal (for existing water networks), cleansing and rinsing (for an existing or new installations water networks) it is important to cleanse all hydraulic pipes to remove sludge and scale by using a specific designed product for cleaning central heating systems.

Also, its recommended to use a product inhibitor for protecting central heating systems against limescale and corrosion, always following manufacturer's instructions and ensuring that the product is suitable for the material used in the water network and the **airH2O 600** unit.

When using chemical treatments and inhibitors always follow manufacturer's instructions and ensure that the product is appropriate for the total water system. Using filling water that does not meet the stated quality requirements can cause a considerably reduce in service life. The responsibility will be out of Hitachi warranties.

The following water quality minimum requirement:

Parameter	Parametric Value	Unit
pH	6.5 to 8.5	-
Conductivity	10 ~ 500	$\mu\text{s}/\text{cm}$
Alkalinity	60 ~ 300	$\text{mg}/\text{l}$
Total Hardness	6 ~ 15	$^\circ\text{f H}$
	0.6 ~ 1.5	$\text{mmol}/\text{l}$
	60 ~ 150	$\text{mg CaCO}_3/\text{l}$
Chlorine	< 50	$\text{mg Cl}^-/\text{l}$
Sulphate	< 50	$(\text{mg SO}_4^{2-}/\text{l})$
Nitrate	< 100	$\text{mg}/\text{l} (\text{NO}_3)$
Iron	< 0.2	$\text{mg}/\text{l} (\text{Fe})$
TDS (Total dissolved solids)	8 ~ 400	ppm
Appearance of the water	Clear and without deposits	-

## ◆ Additional DHW Circuit recommendation

In places where possible hard water areas, to prevent and minimis scale situations, it is recommended to reduce stored water temperature to a maximum of 55°C, as huge scale quantity could damage the water tank and the electrical heater.

Flush the domestic water circuit with at least 10 times its volume of water. The life of the water tank will be shorter if groundwater (spring water, well water, etc..) is used without treatment which can lead to the corrosion of the tank. The water must not be aggressive or encrusting at any time. The result of calculating the Langelier Index should be between +/- 0.5.

In installation locations where the result of Langelier Index calculation are out of the expected value with a tendency to corrosive water, it is recommended to install an active anode accessory.

In the regions where the water is very hard (or out of requirements values) or where the result of Langelier Index calculation are out of expected value with a tendency to hard water, it is recommended fitting a softener system. Please ensure that softener system will be capable of providing effective protection against corrosion. It is recommended to install an active anode accessory.

As DHW Tank water is being used for storing drinking water, this water has to be in accordance with national regulations and Hitachi's quality minimum requirements. The use of softeners, active anodes or others protective systems will not bring a derogation from Hitachi's provided warranty.

### 5.6.3.1 Water filling

#### ◆ Space heating

- 1 Check that a water check valve (ATW-WCV-01 accessory) with a shut-off valve (field supplied) is connected to the water filling point (water inlet connection) for filling the space heating hydraulic circuit (see "5.7 Space heating and DHW").
- 2 Make sure all the valves are open (water inlet/outlet shut-off valves and the rest of valves of the space heating installation components).
- 3 Ensure that the air purgers of the indoor unit and installation are open (turn the indoor unit air purger twice at least).
- 4 Check that the drain pipes connected to the safety valve (and to the drain pan in case of installing the "Cooling kit" accessory) are correctly connected to the general draining system. The safety valve is later used as an air purging device during the water filling procedure.
- 5 Fill the space heating circuit with water until the pressure displayed on the manometer reaches approximately 1.8 bar.

#### NOTE

*While the system is being filled with water, it is highly recommended to operate the safety valve*



manually so as to help with the air purging procedure.

- 6 Remove as much air from inside the water circuit as possible through the indoor air purger and other air vents in the installation (fan coils, radiators...).
- 7 Start the air purge procedure test. There are two modes (Manual or Automatic) which helps in case of installations with heating and DHW operation:
  - a. Manual: Start and stop the unit manually using the unit controller (Run/Stop button) and also using the DSW4 pin 2 of the PCB1 (ON: Forced to derive to DHW coil; OFF: Forced to derive to space heating).
  - b. Automatic: Select the air purge function using the user controller. When the automatic air purge function is running, the pump speed and the position of the 3-way valve (space heating or DHW) are automatically changed.

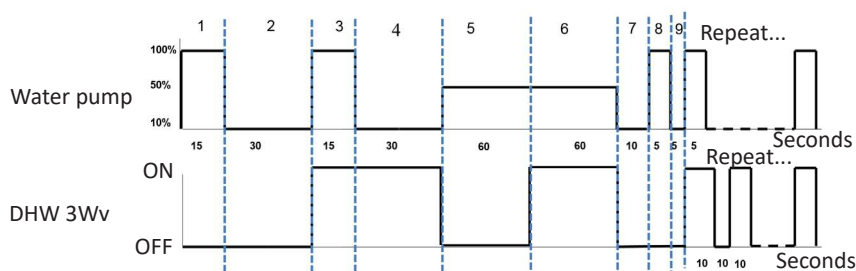

- 8 If a little quantity of air is still remaining in the water circuit, it will be removed by the automatic air purger of the indoor unit during the first hours of operation. Once the air in the installation has been removed, a reduction of water pressure in the circuit is very likely to occur. Therefore, additional water should be filled until water pressure returns to an approximate level of 1.8 bar.

## NOTE

- *The indoor unit is equipped with an automatic air purger (factory supplied) at the highest location of the indoor unit. Anyway, if there are higher points in the water installation, air might be trapped inside water pipes, which could cause system malfunction. In that case, additional air purgers (field supplied) should be installed to ensure no air enters into the water circuit. The air vents should be located at points which are easily accessible for servicing.*
- *The water pressure indicated on the indoor unit manometer may vary depending on the water temperature (the higher temperature, the higher pressure). Nevertheless, it must remain above 1 bar in order to prevent air from entering the circuit.*
- *Fill in the circuit with tap water. The water in the heating installation must comply with EN directive 98/83 EC. Non-sanitary controlled water is not recommended (for example, water from wells, rivers, lakes, etc.)*
- *The maximum water pressure is 3 bar (nominal opening pressure of the safety valve). Provide adequate reduction pressure device in the water circuit to ensure that the maximum pressure is NOT exceeded.*
- *For heating floor system, air should be purged by means of an external pump and an open circuit to prevent the formation of air pockets.*
- *Check carefully for leaks in the water circuit, connections and circuit elements.*

## ◆ Domestic hot water tank

If a domestic hot water tank has been installed, perform the following operations:

### **Heating coil circuit**

Fill the DHW tank heating coil from the space heating circuit filling in point. Follow the instructions explained in the *“5.6.3.1 Water filling”* chapter to correctly perform the operation.

#### CAUTION

- Check that the heating coil pipes are correctly connected between indoor unit and tank before filling the tank's heating coil.
- Ensure the correct water quality of the indoor unit water circuit.

### **Domestic hot water tank and DHW circuit**

- 1 Open the outlet water taps of the DHW installation one after each other, to expel all the air from inside the water circuit.
- 2 Open the main DHW inlet valve in order to fill the tank. If there is a shut-down valve installed in the DHW outlet, open it to allow circulation through the DHW installation.
- 3 When water begins to flow from the outlet water taps of the DHW installation, close all these taps.
- 4 Finally, close the main DHW inlet valve when the pressure reaches approximately 6 bars.

#### CAUTION

- Check carefully for leaks in the water circuit, connections and circuit elements.
- Check that the water pressure in the circuit is lower than 7 bars.
- A pressure and temperature relief valve should be installed at the DHW inlet connection (See *“5.7.5.2 Additional hydraulic optional elements (For DHW)”* section). If it is the case, manually operate its relief valve to ensure that the water flows free through the discharge pipe.
- Fill in the circuit with tap water. The water in the heating installation must comply with EN directive 98/83 EC. Non-sanitary controlled water is not recommended (for example, water from wells, rivers, lakes, etc.)

## **5.6.4 Requirements and recommendations for the hydraulic circuit**

- The maximum piping length depends on the maximum pressure availability in the water outlet pipe. Please check the pump curves.
- The indoor unit is equipped with an air purger (factory supplied) at the highest location of the Indoor Unit. If this location is not the highest of the water installation, air might be trapped inside the water pipes, which could cause system malfunction. In that case additional air purgers (field supplied) should be installed to ensure no air enters the water circuit.

- For heating floor system, the air should be purged by means of an external pump and an open circuit to avoid air bags.
- When the unit is stopped during shut-off periods and the ambient temperature is very low, the water inside the pipes and the circulating pump may freeze, thus damaging the pipes and the water pump. In these cases, the installer shall ensure that the water temperature inside the pipes does not fall below the freezing point. In order to prevent this, the unit has a self-protection mechanism which should be activated (refer to the Service manual, “*Optional functions*” chapter).
- Check that the water pump of the space heating circuit works within the pump operating range and that the water flow is over the pump’s minimum. If the water flow is below the limits, alarm is displayed on the unit (refer to the “*4.3.1 Hydraulic data*” chapter for minimum flow requirements).
- An additional special water filter is highly recommended to be installed on the space heating (field installation), in order to remove possible particles remaining from brazing which cannot be removed by the indoor unit water strainer.
- When selecting a tank for DHW operation, take into consideration the following points:
  - ✓ The storage capacity of the tank has to meet with the daily consumption in order to avoid stagnation of water.
  - ✓ Fresh water must circulate inside the DHW tank water circuit at least one time per day during the first days after the installation has been performed. Additionally, flush the system with fresh water when there is no consumption of DHW during long periods of time.
  - ✓ Try to avoid long runs of water piping between the tank and the DHW installation in order to decrease possible temperature losses.
  - ✓ If the domestic cold water entry pressure is higher than the equipment’s design pressure (6 bar), a pressure reducer must be fitted with a nominal value of 7 bar.
- Ensure that the installation complies with applicable legislation in terms of piping connection and materials, hygienic measures, testing and the possible required use of some specific components like thermostatic mixing valves, Differential pressure overflow valve, etc.
- The maximum water pressure is 3 bar (nominal opening pressure of the safety valve). Provide adequate reduction pressure device in the water circuit to ensure that the maximum pressure is NOT exceeded.
- Ensure that the drain pipes connected to the safety valve and to the air purger are properly driven to avoid water being in contact with unit components.
- Make sure that all field supplied components installed in the piping circuit can withstand the water pressure and the water temperature range in which the unit can operate.
- **airH2O 600** units are conceived for exclusive use in a closed water circuit.
- The internal air pressure of the expansion vessel tank will be adapted to the water volume of the final installation (factory supplied with 0.1 MPa of internal air pressure).
- Do not add any type of glycol to the water circuit.
- Drain taps must be provided at all low points of the installation to permit complete drainage of the circuit during servicing.

## 5.6.5 Water flow control

airH2O 600 pumps can estimate the water flow by electronic calculation. Therefore, there is no need to install a water flow switch with the new airH2O 600 pumps.

However, if a secondary pump is installed, it is necessary to install a water flow control, as the electronic calculation may be affected.

## 5.7 Space heating and DHW

### DANGER

**Do not connect the power supply to the indoor unit prior to filling the space heating circuit (and DHW circuit if it were the case) with water and checking water pressure and the total absence of any water leakage.**

### 5.7.5.1 Additional hydraulic necessary elements for space heating

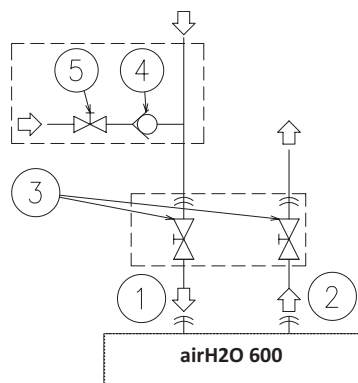

Nature	No.	Part name
Piping connections	1	Water inlet (Space heating)
	2	Water outlet (Space heating)
Factory supplied	3	Shut-off valve (factory-supplied)
Accessories	4	Water check valve (ATW-WCV-01 accessory)
Field supplied	5	Shut-off valve

The following hydraulic elements are necessary to correctly perform the space heating water circuit:

- **Two shut-off valves (factory supplied accessory) (3)** must be installed in the indoor unit. One at the water inlet connection (1) and the other at the water outlet connection (2) in order to make easier any maintenance work.
- **A water check valve (ATW-WCV-01 accessory) (4)** with 1 shut-off valve (field supplied) (5) must be connected to the water filling point when filling the indoor unit. The check valve acts as a safety device to protect the installation against back pressure, back flow and back syphon of non-potable water into drinking water supply net.

## ◆ Additional hydraulic necessary elements for DHW

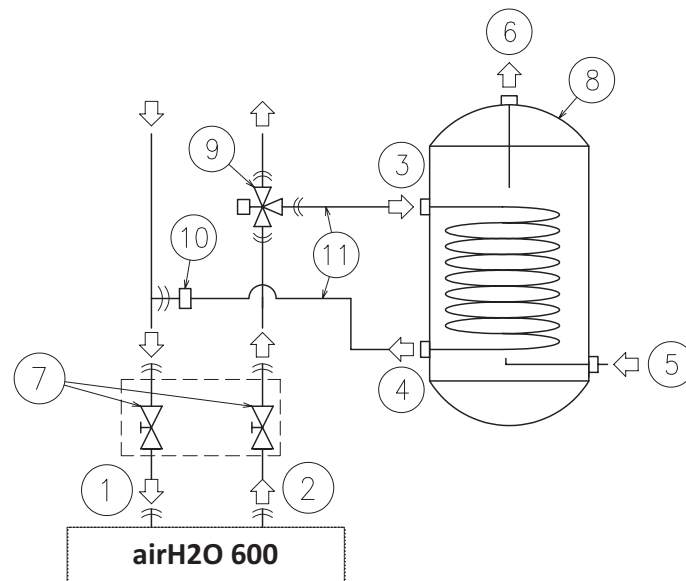

Nature	No.	Part name
Piping connections	1	Water inlet (Space heating)
	2	Water outlet (Space heating)
	3	Heating coil inlet
	4	Heating coil outlet
	5	Water inlet (DHW)
Factory supplied	6	Water outlet (DHW)
Accessories	7	Shut-off valve (factory-supplied)
	8	Domestic hot water tank (DHWT-(200/300)S-3.0H2E accessory)
Field supplied	9	3-way valve (ATW-3WV-01 accessory)
	10	T-branch
	11	Heating coil pipes

**airH2O 600S** is not factory-supplied ready for DHW operation, but it can be used for the production of DHW if the following elements are installed:

- **A domestic hot water tank (DHWT-(200/300)S-3.0H2E accessory) (8)** has to be installed in combination with the indoor unit.
- **A 3-way valve (ATW-3WV-01 accessory) (9)** must be connected at one point of the water outlet pipe of the installation.
- **A T-branch (field supplied) (10)** must be connected at one point of the water inlet pipe of the installation.
- **Two water pipes (field supplied) (11)**. One pipe between 3-way valve and the heating coil inlet (3) of the DHW tank, the other one between the T-branch and the heating coil outlet (4) of the DHW tank.

Additionally, the following elements are required for the DHW circuit:

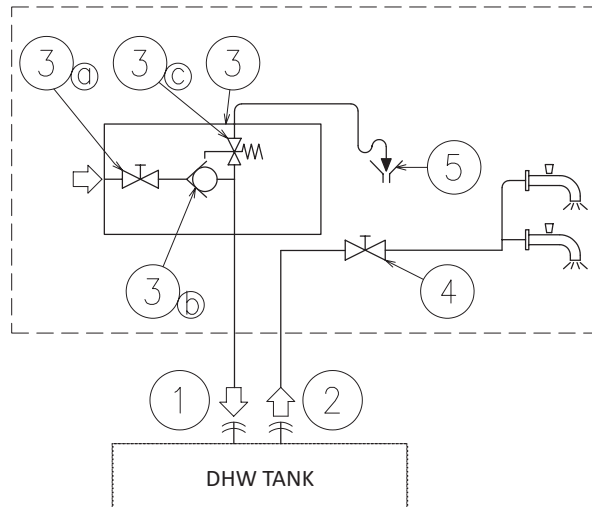

Nature	No.	Part name
Piping connections	1	Water inlet (DHW)
	2	Water outlet (DHW)
Field supplied		Pressure and temperature relief valve
	3	3a Shut-off valve
		3b Water check valve
		3c Pressure relief valve
	4	Shut-off valve
	5	Draining

- **1 Shut-off valve (field supplied):** one shut-off valve (4) must be connected after the DHW outlet connection of the DHW tank (2) in order to make easier any maintenance work.
- **A Security water valve (Field-supplied):** this accessory (3) is a pressure and temperature relief valve that must be installed as near as possible to the DHW inlet connection of the DHW tank (1). It should ensure a correct draining (5) for the discharge valve of this valve. This security water valve should provide the following:
  - ✓ Pressure protection
  - ✓ Non-return function
  - ✓ Shut-off valve
  - ✓ Filling
  - ✓ Draining

## NOTE

*The discharge pipe should always be open to the atmosphere, free of frost and in continuous slope to the down side in case that water leakage exists.*

## 5.7.5.2 Additional hydraulic optional elements (For DHW)

In case of a recirculation circuit for the DHW circuit:

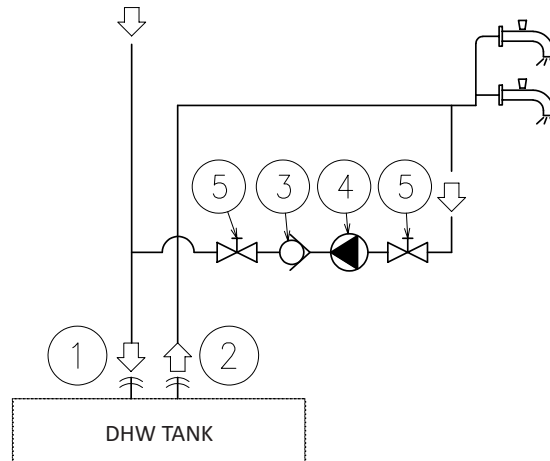

Nature	No.	Part name
Piping connections	1	Water inlet (DHW)
	2	Water outlet (DHW)
Accessories	3	Water check valve (ATW-WCV-01 accessory)
Field supplied	4	Water pump
	5	Shut-off valve

- **1 Recirculation water pump (field supplied):** this water pump (3) will help to correctly recirculate the hot water to the DHW inlet.
- **1 Water check valve (ATW-WCV-01 accessory):** this Hitachi accessory (3) is connected after the recirculation water pump (4) in order to ensure the non-return of water.
- **2 Shut-off valves (field supplied) (5):** one before the recirculation water pump (4) and other after the water check valve accessory (3).

## Electrical and control settings

6.1	General check .....	48
6.2	Electrical connection .....	50
6.2.1	Wiring size .....	50
6.2.2	Minimum requirements of the protection devices .....	52
6.3	Setting of DIP switches and RSW switches.....	54
6.3.1	Location of DIP switches and rotary switches.....	54
6.3.1.1	Function of DIP switches and rotary switches .....	54
6.3.1.2	LED indication.....	58
6.4	Terminal board connections.....	59
6.4.1	Table board 1 .....	59
6.4.2	Table board 2 .....	60
6.4.2.1	Indoor/outdoor communication wiring (TB2) / ATW-RTU Communication / Central Devices Communication .....	60
6.4.2.2	Summary of terminal board connections .....	61
6.4.2.3	Input terminals (Default input functions).....	63



## 6.1 General check

- Make sure that the following conditions related to power supply installation are satisfied:
  - ✓ The power capacity of the electrical installation is large enough to support the power demand of the **airH2O 600** system (outdoor unit + indoor unit + DHW tank (if apply)).
  - ✓ The power supply voltage is within  $\pm 10\%$  of the rated voltage.
  - ✓ The impedance of the power supply line is low enough to avoid any voltage drop of more than 15% of the rated voltage.
- Following the Council Directive 2004/108/EC, relating to electromagnetic compatibility, the table below indicates the Maximum permitted system impedance  $Z_{max}$  at the interface point of the user's supply, in accordance with EN 61000-3-11.

Model	Power supply	Operation mode	$Z_{max}$ ( $\Omega$ ) (*)
RWM-(1.5-3.0)R3E	~ 230V 50Hz	Without electric heaters	-
		With electric heater	-
		With DHW tank heater	-
		With electric and DHW tank heaters	0.28
	3N~ 400V 50Hz	Without electric heaters	-
		With electric heater	-
		With DHW tank heater	-
		With electric and DHW tank heaters	-
RWM-(8/10)N3E	3N~ 400V 50Hz	Without electric heaters	-
		With electric heater	-
		With DHW tank heater	-
		With electric and DHW tank heaters	0.49
RWM-(3.5-6.0)R3E	~ 230V 50Hz	Without electric heaters	-
		With electric heater	0.28
		With DHW tank heater	-
		With electric and DHW tank heaters	0.19
	3N~ 400V 50Hz	Without electric heaters	-
		With electric heater	-
		With DHW tank heater	-
		With electric and DHW tank heaters	-

### NOTE

The data corresponding to DHW tank heater is calculated in combination with the domestic hot water tank accessory "DHWT-(200/300)S-3.0H2E".

The status of Harmonics for each model, regarding compliance with EN 61000-3-2 and EN 61000-3-12 is as follows:

	Models
Equipment complying with EN 61000-3-2	RWM-1.5R3E(~1)(~3N)
	RWM-2.0R3E(~1)(~3N)
	RWM-2.5R3E(~1)(~3N)
	RWM-3.0R3E(~1)(~3N)
	RWM-3.5R3E(~3N)
	RWM-4.0R3E(~3N)
	RWM-5.0R3E(~3N)
	RWM-6.0R3E(~3N)
	RWM-8.0N3E(~3N)
	RWM-10.0N3E(~3N)
Equipment complying with EN 61000-3-12	RWM-3.5R3E(~1)
	RWM-4.0R3E(~1)
	RWM-5.0R3E(~1)
	RWM-6.0R3E(~1)

- Check to ensure that existing installation (main power switches, circuit breakers, wires, connectors and wire terminals) already complies with the national and local regulations.
- The use of the DHW tank heater is disabled as factory setting. If it is desired to enable the DHW tank heater operation during normal indoor unit operation, adjust the DSW4 pin 3 of the PCB1 to the ON position and use the adequate protections. Refer to the section **“6.2 Electrical connection”** for the detailed information.

## 6.2 Electrical connection

### CAUTION

- Check to ensure that the field supplied electrical components (mains power switches, circuit breakers, wires, connectors and wire terminals) have been properly selected according to the electrical data indicated on this chapter and they comply with national and local codes. If it is necessary, contact with your local authority in regards to standards, rules, regulations, etc.
- Use a dedicated power circuit for the indoor unit. Do not use a power circuit shared with the outdoor unit or any other appliance.

### 6.2.1 Wiring size

Use wires which are not lighter than the polychloroprene sheathed flexible cord (code designation 60245 IEC 57).

Model	Power supply	Operation mode	Maximum current (A)	Power supply cables	Transmitting cables	Actuator cables
				EN60335-1	EN60335-1	EN60335-1
RWM-(1.5-3.0)R3E	~ 230V 50Hz	Without electric heaters	0.64	2 x 0.75 mm <sup>2</sup> + GND	2 x 0.75 mm <sup>2</sup>	2 x 0.75 mm <sup>2</sup> (Shielded)
		With electric heater	13.7	2 x 2.5 mm <sup>2</sup> + GND		
		With DHW tank heater	13.7	2 x 2.5 mm <sup>2</sup> + GND		
		With electric and DHW tank heaters	26.7	2 x 6.0 mm <sup>2</sup> + GND		
	3N~ 400V 50Hz	Without electric heaters	0.6	4 x 0.75 mm <sup>2</sup> + GND		
		With electric heater	5	4 x 2.5 mm <sup>2</sup> + GND		
		With DHW tank heater	13.7	4 x 2.5 mm <sup>2</sup> + GND		
		With electric and DHW tank heaters	18	4 x 4.0 mm <sup>2</sup> + GND		

Model	Power supply	Operation mode	Maximum current (A)	Power supply cables	Transmitting cables	Actuator cables
				EN60335-1	EN60335-1	EN60335-1
RWM-(3.5-6.0)R3E	~ 230V 50Hz	Without electric heaters	0.66	2 x 0.75 mm <sup>2</sup> + GND	2 x 0.75 mm <sup>2</sup>	2 x 0.75 mm <sup>2</sup> (Shielded)
		With electric heater	26.7	2 x 6 mm <sup>2</sup> + GND		
		With DHW tank heater	13.7	2 x 2.5 mm <sup>2</sup> + GND		
		With electric and DHW tank heaters	39.8	2 x 10.0 mm <sup>2</sup> + GND		
	3N~ 400V 50Hz	Without electric heaters	0.7	4 x 0.75 mm <sup>2</sup> + GND		
		With electric heater	9.3	4 x 2.5 mm <sup>2</sup> + GND		
		With DHW tank heater	13.7	4 x 2.5 mm <sup>2</sup> + GND		
		With electric and DHW tank heaters	22.4	4 x 6.0 mm <sup>2</sup> + GND		
RWM-(8.0/10.0)N3E	3N~ 400V 50Hz	Without electric heaters	1.16	4 x 0.75 mm <sup>2</sup> + GND	2 x 0.75 mm <sup>2</sup>	2 x 0.75 mm <sup>2</sup> (Shielded)
		With electric heater	14.2	4 x 4 mm <sup>2</sup> + GND		
		With DHW tank heater	14.2	4 x 4 mm <sup>2</sup> + GND		
		With electric and DHW tank heaters	27,2	4 x 6.0 mm <sup>2</sup> + GND		

**i** NOTE

The data corresponding to DHW tank heater is calculated in combination with the domestic hot water tank accessory "DHWT-(200/300)S-3.0H2E".

## 6.2.2 Minimum requirements of the protection devices

### CAUTION

- Ensure specifically that there is an Earth Leakage Breaker (ELB) installed for the units (outdoor and indoor unit).
- If the installation is already equipped with an Earth Leakage Breaker (ELB), ensure that its rated current is large enough to hold the current of the units (outdoor and indoor unit).

### NOTE

- Electric fuses can be used instead of magnetic Circuit Breakers (CB). In that case, select fuses with similar rated values as the CB.
- The Earth Leakage Breaker (ELB) mentioned on this manual is also commonly known as Residual Current Device (RCD) or Residual Current Circuit Breaker (RCCB).
- The Circuit Breakers (CB) are also known as Thermal-Magnetic Circuit Breakers or just Magnetic Circuit Breakers (MCB).

Model	Power supply	Operation mode	Max current (A)	CB (A)	ELB (n° of poles/A/mA)
RWM-(1.5-3.0)R3E	~ 230V 50Hz	Without electric heaters	0.64	5	2/40/30
		With electric heater	13.7	16	
		With DHW tank heater	13.7	16	
		With electric and DHW tank heaters	26.7	32	
	3N~ 400V 50Hz	Without electric heaters	0.6	5	4/40/30
		With electric heater	5	10	
		With DHW tank heater	13.7	16	
		With electric and DHW tank heaters	18	20	

Model	Power supply	Operation mode	Max current (A)	CB (A)	ELB (n° of poles/A/mA)
RWM-(3.5-6.0)R3E	~ 230V 50Hz	Without electric heaters	0.66	5	2/40/30
		With electric heater	26.7	32	
		With DHW tank heater	13.7	16	
		With electric and DHW tank heaters	39.8	50	
	3N~ 400V 50Hz	Without electric heaters	0.7	5	4/40/30
		With electric heater	9.3	16	
		With DHW tank heater	13.7	16	
		With electric and DHW tank heaters	22.4	25	

Model	Power supply	Operation mode	Max current (A)	CB (A)	ELB (n° of poles/A/mA)
RWM-(8.0/10.0)N3E	3N~ 400V 50Hz	Without electric heaters	1.16	5	4/40/30
		With electric heater	14.2	20	
		With DHW tank heater	14.2	20	
		With electric and DHW tank heaters	27.2	32	

## NOTE

The data corresponding to DHW tank heater is calculated in combination with the domestic hot water tank accessory "DHWT-(200/300)S-3.0H2E".

## 6.3 Setting of DIP switches and RSW switches

### 6.3.1 Location of DIP switches and rotary switches

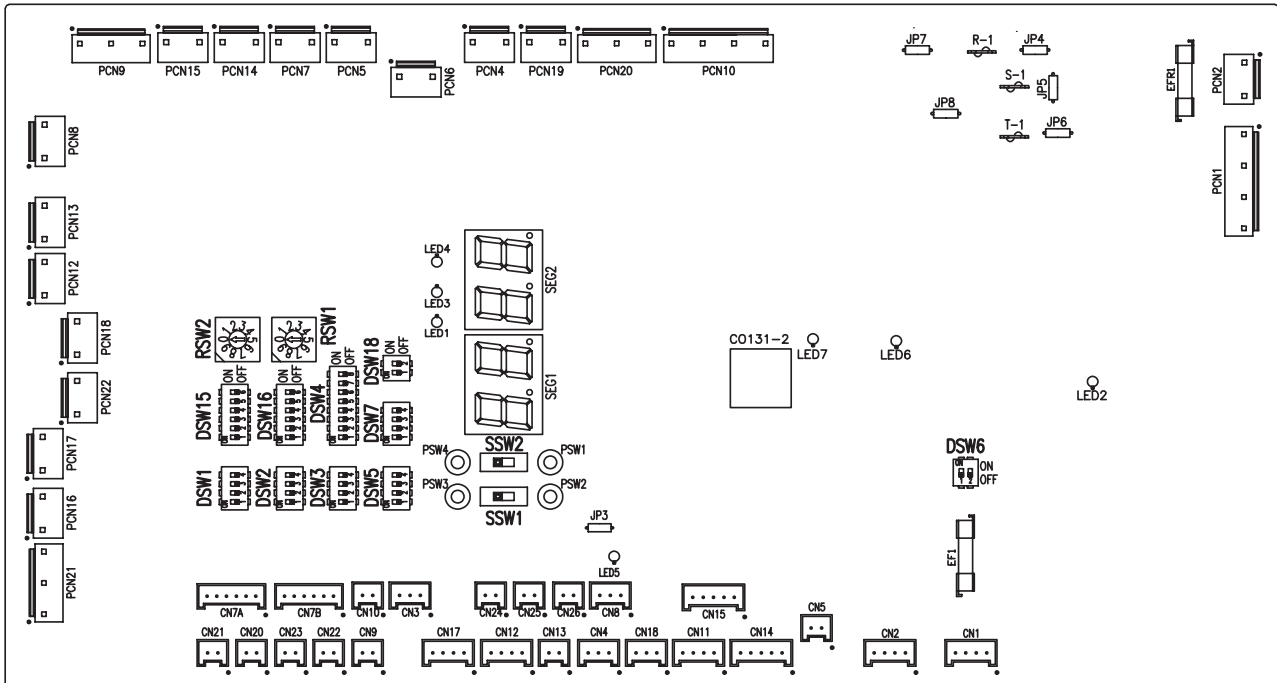

#### 6.3.1.1 Function of DIP switches and rotary switches

##### **i** NOTE

- The mark “■” indicates the dip switches positions.
- No mark “■” indicates pin position is not affected.
- The figures show the settings before shipment or after selection.
- “Not used” means that the pin must not be changed. A malfunction might occur if changed.

##### **!** CAUTION

Before setting dip switches, first turn the power supply OFF and then set the position of dip switches. If the switches are set without turning the power supply OFF, the contents of the setting are invalid.

## ◆ DSW1: Additional setting 0

Factory setting. No setting is required.

**DSW1**

airH2O 600S (\*)







### **i** NOTE

(\*): In case of installing the “Cooling kit” accessory, set the pin 4 of DSW1 to ON in order to enable the cooling operation.

## ◆ DSW2: Unit capacity setting

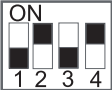

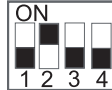

Factory setting. No setting is required.

**DSW2**

1.5 HP	2.0 HP	2.5 HP	3.0 HP	3.5 HP
				

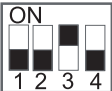
**DSW2**

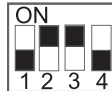
4.0HP	5.0HP	6.0HP	8.0 HP	10.0 HP
				

## ◆ DSW3: Additional setting 1

**DSW3**

Setting before shipment



---

1-step heater for 3-phase unit

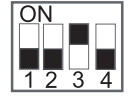

## ◆ DSW4: Additional setting 2

**DSW4**

Setting before shipment

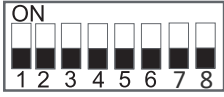



## DSW4

DHW defrost

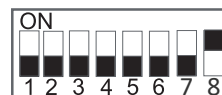

Heater forced OFF

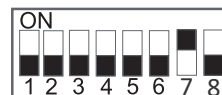

Unit and installation pipes antifreeze protection

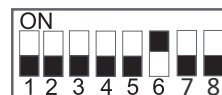

Standard / ECO water pump operation

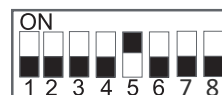

Electric heater or boiler emergency mode

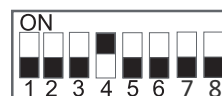

DHW tank's heater operation

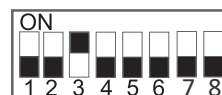

DHW 3-way valve forced ON

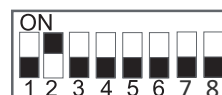

### CAUTION

- Never turn all DSW4 dip switch pins ON. If this happens, the software of the unit will be removed.
- Never activate “Heater Forced OFF” and “Electric heater or boiler emergency mode” at the same time.

### ◆ DSW5: Additional setting 3

In the cases where the outdoor unit is installed into a location where its own outdoor ambient temperature sensor can not give a suitable temperature measurement to the system, it is available the 2nd outdoor ambient temperature sensor as accessory. By means of DSW1&2 setting, the preferable sensor for each circuit can be selected.

## DSW5

Factory setting



Outdoor unit sensor for circuits 1 and 2



Outdoor unit sensor for circuit 1; Auxiliary sensor for circuit 2



## DSW5

Auxiliary sensor for circuit 1; Outdoor unit sensor for circuit 2

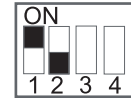

Auxiliary sensor instead of outdoor unit sensor for both circuits

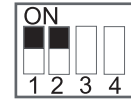

Use the maximum temperature value between Two3 (boiler / heater thermistor) and Two (water outlet thermistor) for water control

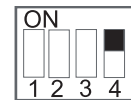

### ◆ DSW6 (only if available): Not used

## DSW6

Factory setting  
(Do not change)



### ◆ DSW7: Additional setting 4

## DSW7

Factory setting



Compatibility with ATW-RTU-04 (When cooling mode operation is needed)



### ◆ DSW15 & RSW2: Refrigerant cycle address

## DSW15 & RSW2

Factory setting



Refrigerant cycle address setting (Required only when **airH2O 600** Cascade Controller is installed)

Example of system setting with a value of: 5







## ◆ DSW16 & RSW1: Not used

DSW16 & RSW1	
Factory setting (Do not change)	





## ◆ DSW18: Not used

DSW18	
Factory setting (Do not change)	

## ◆ SSW1: Remote/Local

SSW1		
Factory setting	Remote	
Remote operation	Local	
Local operation	Remote	
	Local	

## ◆ SSW2: Heat/Cool (when SSW1 is in local setting)

SSW2		
Factory setting	Heat	
Heat operation	Cool	
Cooling operation (when cooling kit installed)	Heat	
	Cool	

### 6.3.1.2 LED indication

Name	Colour	Indication
LED1	Green	Power indication
LED2	Red	Power indication
LED3	Red	Heat pump operation (Thermo-ON/OFF)
LED4	Yellow	Alarm (flickering with 1 sec interval)
LED5	Green	Not used
LED6	Yellow	H-LINK transmission
LED7	Yellow	H-LINK transmission for unit controller

## 6.4 Terminal board connections

### 6.4.1 Table board 1

#### ◆ Main power supply

The main power supply connection is wired to the Terminal board (TB1) as follows:

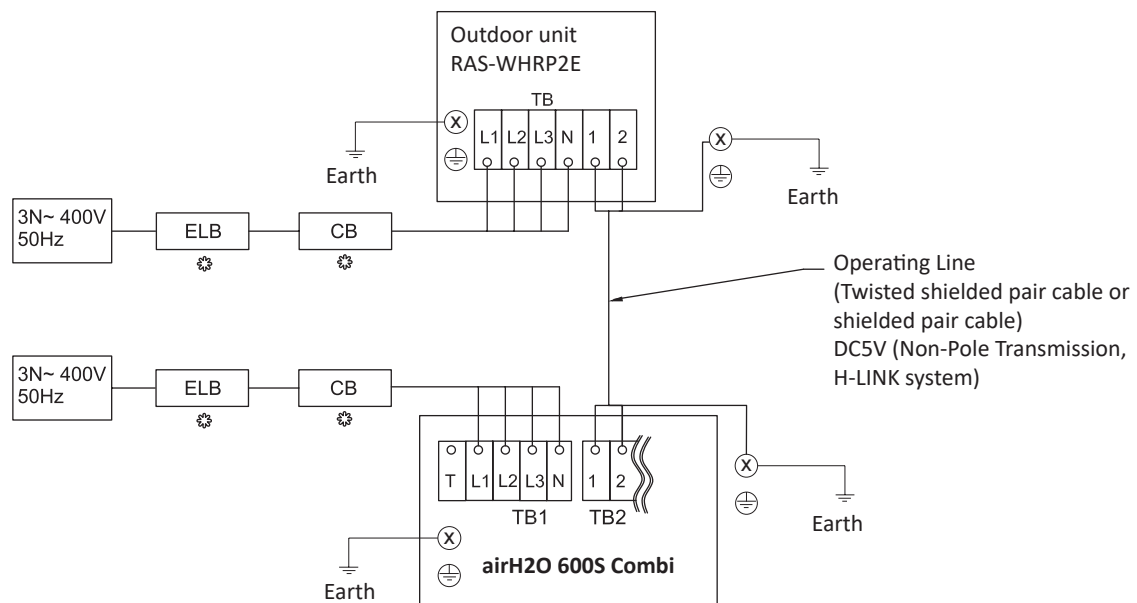
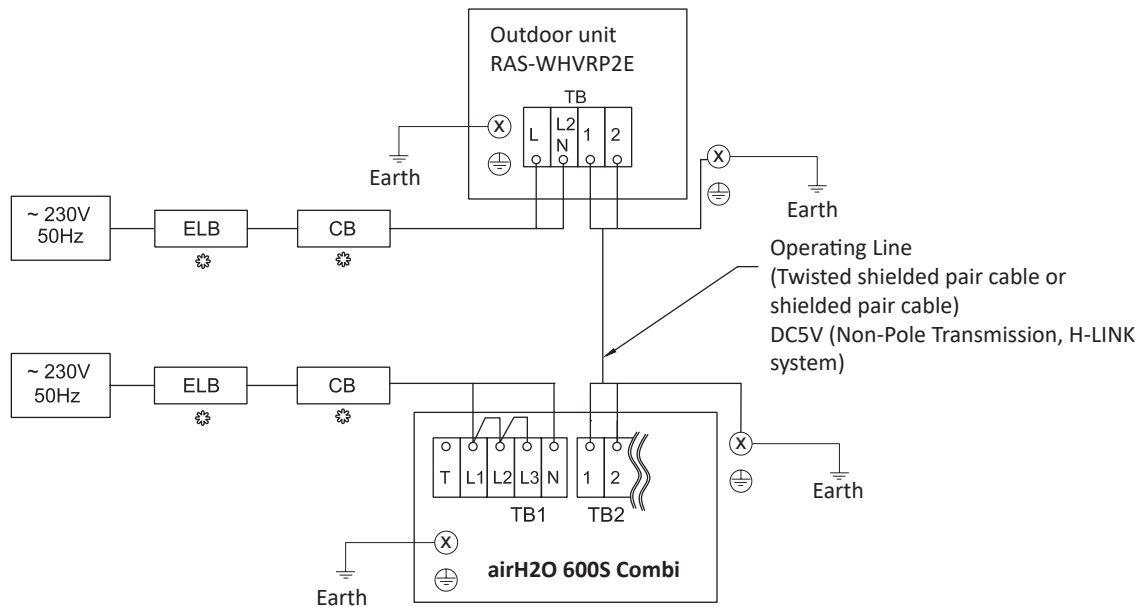

## 6.4.2 Table board 2

### 6.4.2.1 Indoor/outdoor communication wiring (TB2) / ATW-RTU Communication / Central Devices Communication

- The transmission is wired to terminals 1-2.
- The H-LINK II wiring system requires only two transmission cables that connect the indoor unit and the outdoor unit in case of split system and also connect the indoor unit with ATW-RTU-07 or Central devices like ATW-KNX-02 and Cascade controller (ATW-YCC-04) or ATW-TYD-01.

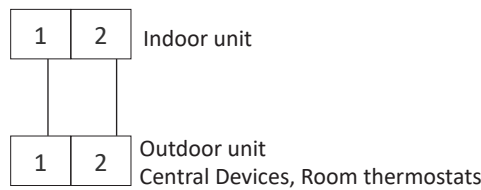

- Use twist pair wires (0.75 mm<sup>2</sup>) for operation wiring between outdoor unit and indoor unit. The wiring must consist of 2-core wires (Do not use wire with more than 3 cores).
- Use shielded wires for intermediate wiring to protect the units from noise interference, with a length of less than 300 m and a size in compliance with local codes.
- In the event that a conduit tube for field-wiring is not used, fix rubber bushes to the panel with adhesive.

#### CAUTION

*Ensure that the transmission wiring is not wrongly connected to any live part that could be damaged the PCB.*

Input and output terminals give the possibility to configure the installation according to the needs of the user. The default settings and I/O terminals reach most of the options necessary for an optimal performance of the system. Additionally, the settings can be modified through the unit controller, and input/output terminals can be used, if required, to have additional options.

## 6.4.2.2 Summary of terminal board connections

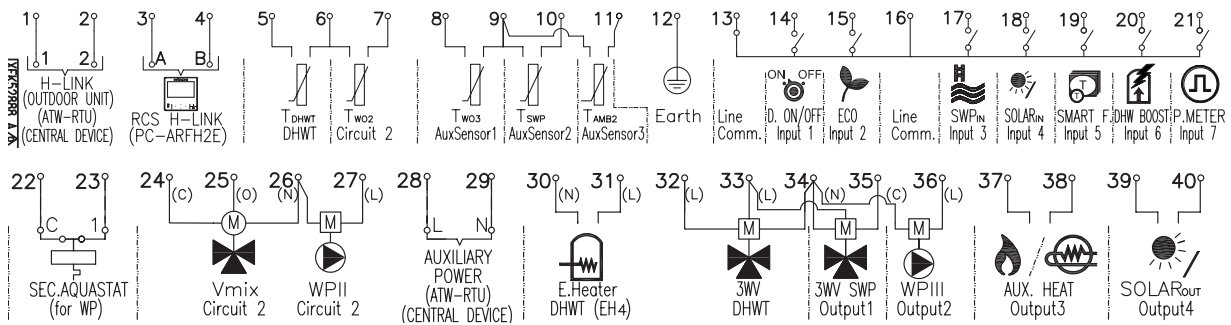

Mark	Part name	Description
<b>TERMINAL BOARD 1 (TB1)</b>		
N	~ 230V 50Hz	
L1	3N~ 400V 50Hz	Main power supply connection
L2		
L3		
<b>TERMINAL BOARD 2 (TB2)</b>		
1	H-LINK commutation	The H-LINK transmission has to be done between the indoor unit and the terminals 1-2 of either outdoor unit, ATW-RTU or any other central device.
2		
3	H-LINK communication for remote control switch	Terminals for the connection of the <b>airH2O 600</b> unit controller.
4		
5	DHW tank's thermistor	The DHW sensor is used to control the temperature of the domestic hot water tank.
6	Common thermistor	Common terminal for thermistor.
7	Thermistor for water outlet temperature of second cycle	The sensor is used for the second temperature control and should be positioned after the mixing valve and the circulation pump.
8	Thermistor for water outlet temperature after hydraulic separator	Water sensor for hydraulic separator, buffer tank or boiler combination.
9	Common thermistor	Common terminal for thermistors.
10	Thermistor for swimming pool water temperature	The sensor is used for the swimming pool temperature control and should be positioned inside plate heat exchanger of the swimming pool.
11	Thermistor for second ambient temperature	The sensor is used for the second ambient temperature control and it should be positioned outdoors.
12	Earth	Earth connection for the 3 way valve and water pump
13	Common line	Terminal Line common for input 1 and input 2.
14	Input 1 (Demand ON/OFF) (*)	The air to water heat pump system has been designed to allow the connection of a remote thermostat to effectively control your home's temperature. Depending on the room temperature, the thermostat will turn the split air to water heat pump system ON and OFF.
15	Input 2 (ECO mode) (*)	Available signal which allows to reduce the water setting temperature of circuit 1, circuit 2 or both.
16	Common line	Terminal Line common for inputs 3, 4, 5, 6, 7.
17	Input 3 (Swimming pool) (*)	Only for swimming pool installations: It is necessary to connect an external input to the air to water heat pump to provide signal when the water pump of swimming pool is ON.
18	Input 4 (Solar) (*)	Available input for Solar combination with Domestic Hot Water Tank.

Mark	Part name	Description
19	Input 5 (Smart function) (*)	For the connection of an external tariff switch device to switch OFF the heat pump during peak electricity demand period. Depending on the setting, the heat pump or DHWT will be blocked when signal is open/closed.
20	Input 6 (DHW boost) (*)	Available input for an instantaneous heating of the domestic hot water of the tank.
21	Input 7 (Power meter)	The measuring of the real power consumption can be done connecting an external power meter. The number of pulses of the power meter is a variable which must be set. By this, every pulse input is added into corresponding operation mode (Heating, Cooling, DHW Operation). Two possible options: - One power meter for all installation (IU+OU). - Two separated power meters (one for IU and one for OU).
22	Aquastat security for circuit 1	Terminals intended for the connection of the Aquastat security accessory (ATW-AQT-01) for controlling water temperature of the circuit 1.
23	(WP1)	
24(C)	Mixing valve close	When a mixing system is required for a second temperature control, these outputs are necessary to control the mixing valve.
25(O)	Mixing valve open	
26(N)	N Common	
27(L)	Water Pump 2 (WP2)	When there is a second temperature application, a secondary pump is the circulating pump for the secondary heating circuit.
28	Auxiliary power	Power supply for Room thermostats and central device
29		
30(N)	Electrical Heater DHW Output	If DHW tank contains an electric heater, the air to water heat pump can activate it if the heat pump cannot achieve the required DHW temperature by itself.
31(L)		
32(C)	3-way valve for DHW tank (output)	The air to water heat pump can be used to heat DHW. This output will be on when DHW is activated.
33(L)	Common line (phase)	Common terminal for the 3-way valve for DHW tank.
34(N)	N common (neutral)	Neutral terminal common for 3-way valve of DHW tank and outputs 1 and 2.
35(L)	Output 1 (3-way valve for swimming pool) (*)	The air to water heat pump can be use to heat swimming pool. This output will be ON when swimming pool is activated.
36(L)	Output 2 (Water pump 3 (WP3)) (*)	When there is a hydraulic separator or buffer tank, additional water pump (WP3) is needed.
37	Output 3 (Auxiliary boiler or electric heater) (*)	The boiler can be used to alternate with the heat pump when the heat pump cannot achieve the required temperature by itself.
38		A water electric heater (as accessory) can be used to provide the additional heating required on the coldest days of the year.
39	Output 4 (Solar) (*)	Output for solar combination with Domestic Hot Water Tank.
40		

## NOTE

(\*): Inputs and outputs explained in the table are the factory-set options. By means of the unit controller, some other inputs and outputs functions can be configured and used. Please, refer to the Service Manual for detailed information.

## 6.4.2.3 Input terminals (Default input functions)

### ◆ Room thermostat communication cables

There are two different room thermostat types as accessory

#### **Optional wireless intelligent room thermostat (TB2) ATW-RTU-07**

Only for wireless room thermostat accessory: the receiver is connected to the polarity-free terminals 1 and 2.

The Wireless room thermostat and the Intelligent receiver are already configured to communicate with each other. If the Wireless room thermostat or the Intelligent receiver is replaced or an additional second temperature circuit thermostat is added, it is necessary to rebind them as explained in the manual of the Wireless intelligent room thermostat.

The Intelligent receiver is connected to the indoor unit table board as shown in the next picture:

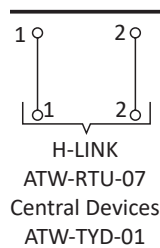

#### **Optional wireless connected room thermostat (ATW-RTU-12)**

airH2O 600 with embeded wifi and bluetooth are ready to connect ATW-RTU-12 room thermostat. Please refer to room thermostat ATW-RTU-12 installation manual for bining processs.

### ◆ PC-ARFH3E connection

In cases where another PC-ARFH3E must be connected as a second thermostat, the connections between PC-ARFH3E and the indoor unit must be done in terminals 3 and 4:

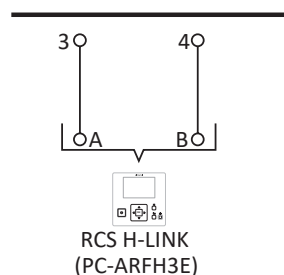



## ◆ DHWT Thermistor ( $T_{DHWT}$ )

For those cases in which a tank is installed as accessory, a thermistor must be installed to control the water temperature. The connection for this thermistor must be done between terminals 5 and 6 of the TB2.

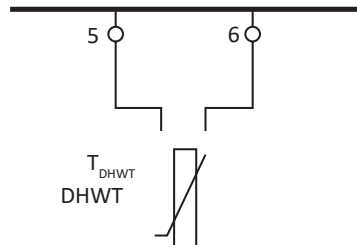

## ◆ Water outlet thermistor for circuit 2 ( $T_{wo2}$ )

When the installation is configured with a second circuit the thermistor for the water outlet temperature have to be connected between terminals 6 and 7 of the terminal board 2.

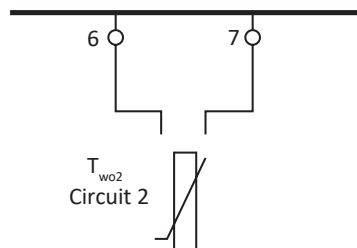

## ◆ Earth

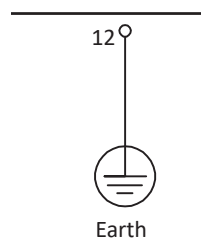

## ◆ Optional wireless ON/OFF room thermostat ATW-RTU-04

The heat pump system has been designed to allow the connection of a remote ON/OFF thermostat to effectively control the home temperature. Depending on the room temperature, the thermostat will turn the system to ON or OFF.

### a. If no thermostat is installed

Terminals 13 and 14 are jumped if there is no ON/OFF receiver connected. When no remote thermostat is installed the operating condition for the unit (Thermo ON/OFF) will be controlled by the water calculation control system.

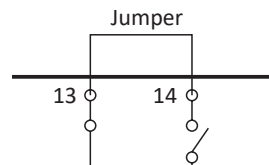

### b. Installation of the ATW-RTU-04 or other ON/OFF Thermostat, connect thermostat between terminals 13 and 14

In case of setting an installation with ON/OFF room thermostat between terminals 13 and 14 of the Terminal board 2, connect the RF receiver as shown in the following picture.

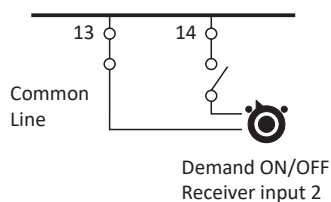

Thermostat requirements:

- Power supply: 230V AC
- Contact voltage: 230V

## **i** NOTE

- Enable use of the ON/OFF room thermostat by setting the configuration in the user's control.
- In case of setting an installation with 2 circuits (Circuit 1 and Circuit 2) and a different Demand ON/OFF is used for each of them, please refer to "6.4.2.2 Summary of terminal board connections" section in this chapter.
- Auxiliary power supply is available for thermostats and central devices (28 and 29 terminals of TB2).
- Ensure that ON/OFF room thermostat has enough operation hysteresis to avoid constants starting and stopping demands in **airH2O 600** system.

## ◆ ECO (Default for input 2)

When enabled at Unit controller, both for circuit 1 and circuit 2, also for heating and cooling, this input switches the indoor unit into an ECO mode by adjusting its settings only when input is closed.

The input can come from a push button, a thermostat or any other external device with that purpose.

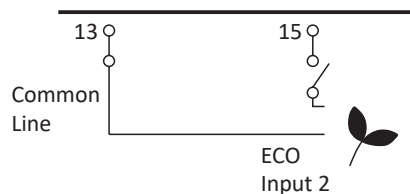

## ◆ Swimming pool (Default for input 3)

When it is necessary to control the temperature of the swimming pool water, a connection between the heat pump and the corresponding sensor must be done on terminals 16 and 17 at the Terminal board (input 4).

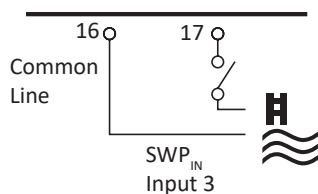

## ◆ Solar (Default for input 4)

This input comes from a solar panel sensor. The solar combination by input demand allows HSW to be heated by solar system when there is enough solar energy available. The connection of this input signal has to be done between terminals 16 and 18 at TB2.

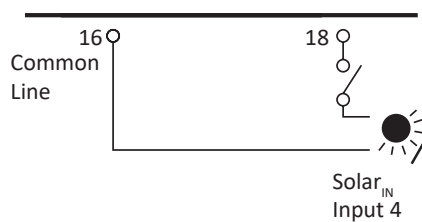

## ◆ Smart tariff (Default for input 5)

This function can be used to block or limit the heat pump. It allows an external Smart switch device to switch off or limit the heat pump during a period of peak electricity demand. Terminals 16 and 19 of the TB2.

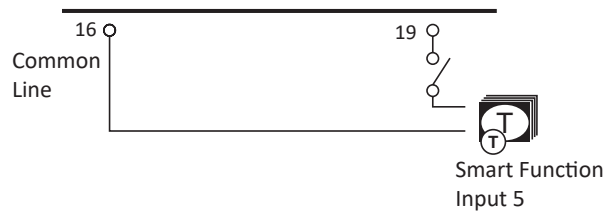

## ◆ DHW boost (Default for input 6)

This function allows a request for a one-time heating up of the domestic hot water temperature. The input can be sent by a push button, a NC contact and a NO contact. This input is switched on terminals 16 and 20 of the TB2.

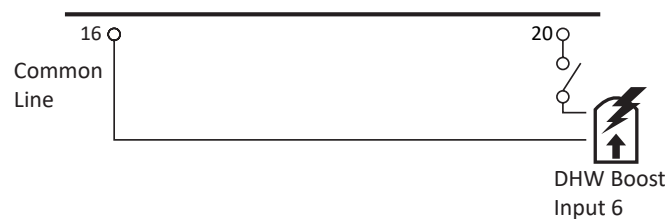

## ◆ Power Meter (Default for input 7)

This function is used to monitor real consumption of the system by means an external power meter device connected at this input. The calculation method is done by measuring real consumption of the whole installation with one power meter device or 2 separate power meter (one for indoor unit and another one for outdoor unit).

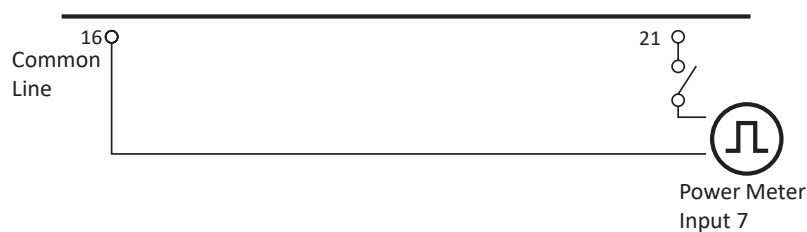

## ◆ Aquastat for circuit 1

Aquastat is a security accessory to control in order to prevent high water temperature entering into floor system (Circuit 1). This devices must be connected to terminals 22 & 23 for circuit 1.

When this devices is activated because of the high temperature of the water, it stops the water pump in order to stop the flow of water to the heating floor.

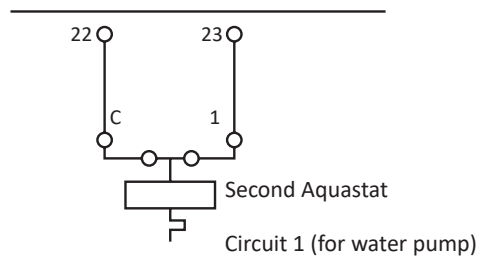

### Output terminals (Default output functions)

## ◆ Mixing valve for Circuit 2

The mixing valve is controlled to maintain the second heating temperature at the second heating temperature set point. The control system decides how much to open or close the mixing valve to achieve the desired position of the valve.

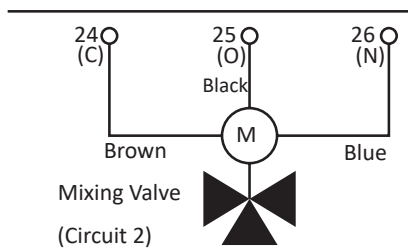

Valve requirements:

- Power supply: 230V AC 50Hz
- Maximum running current: 100mA

## ◆ Water pump 2 Circuit 2

In case of a second circuit installation (second temperature level) the secondary pump is the circulating pump for the second heating temperature.

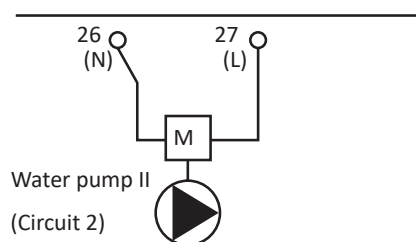

Pump requirements:

- Power supply: 230V AC 50Hz
- Maximum running current: 500mA (An auxiliary relay must be installed in case of high consumption of the water pump).

## ◆ Electrical heater DHWT output

In those cases where a DHW tank is installed with an electrical heater, the Air to Water heat pump can activate the electric heater of the tank when the heat pump cannot achieve the required DHW temperature by itself.

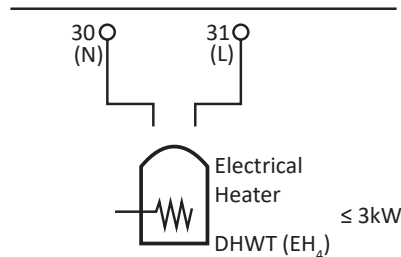

### ⚠ CAUTION

When using a DHW tank other than those from Hitachi, the maximum connectable heater load is 3 kW (connected to TB2 terminals 30-31).

## ◆ 3 Way valve for DHW tank output

airH2O 600 units can be used to heat DHW. The signal is used on a 3-way motorized diverting valve and to provide control of supply water flow (water flow for space heating when there is no signal, and water flow for DHW when signal is ON)

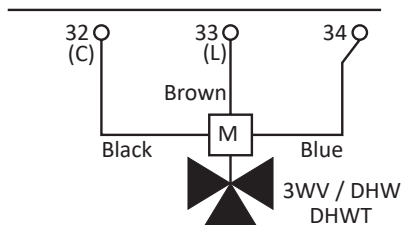

Valve requirements:

- Power supply: 230V AC 50Hz
- Maximum running current: 100mA

### Output terminals (Optional output functions)

## ◆ 3 Way valve for Swimming pool (Default for Output 1)

airH2O 600 units can be used to heat the water of a swimming pool. The signal is used on a 3-way motorized diverting valve and to provide control of supply water flow for the swimming pool. This output is available when the function is enabled from the Unit controller.

Using the appropriate wiring, connect the valve cables as shown in the previous picture.

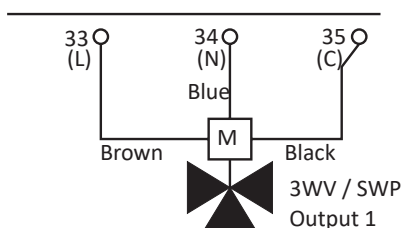

Valve requirements:

- Power supply: 230V AC 50Hz
- Maximum running current: 100mA

## ◆ Water pump 3 (Default for Output 2)

When the boiler is configured with the heat pump or needs an additional pump for the system, a hydraulic separator or buffer tank must be used to ensure a correct hydraulic balance

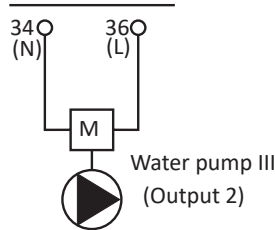

## ◆ Auxiliary boiler or heater (Default for Output 3)

The auxiliary boiler or heater can be used when the heat pump cannot achieve the require temperature by itself.

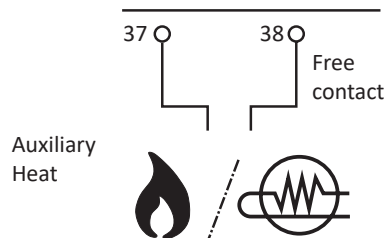

## ◆ Solar (Default for output 4)

This output is used when solar mode is enabled (from Unit controller) and the temperature in the solar panel rises above the water temperature in the domestic hot water tank (DHWT). The connection between terminals 39 and 40 shall be closed in order to activate the dedicated water pump for solar panel combination.

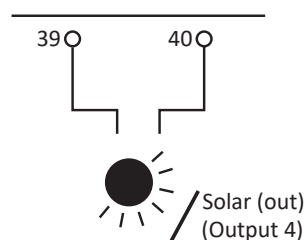



## Maintenance

7.1	Removing the covers .....	72
7.1.1	Removing the indoor unit service cover .....	72
7.2	Removing indoor unit electrical box .....	73
7.3	Space heating pipes connection .....	74
7.4	Drain pipes connection.....	74
7.5	Cover assembly.....	75
7.6	Test and check .....	76



## 7.1 Removing the covers

If it is necessary to access to the indoor unit components, please follow these operations.

### 7.1.1 Removing the indoor unit service cover

#### NOTE

*The indoor unit service cover needs to be removed for any task inside the indoor unit.*

- 1 Remove the screws which fix the service cover.

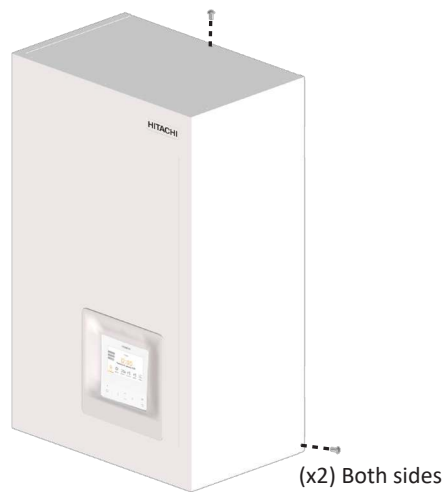

- 2 Slide the service cover slightly upward and remove it pulling to back.



#### CAUTION

- Pay attention of no falling off the service cover.
- Take care when removing service cover; the parts inside the unit could be hot.

## 7.2 Removing indoor unit electrical box

### DANGER

- *Disconnect the unit from the power supply before touching any of the parts in order to avoid an electrical shock.*
- *Do not touch the switch for DHW tank heater operation when handling the electrical box. Keep the position of this switch in factory setting position ("Automatic" operation).*

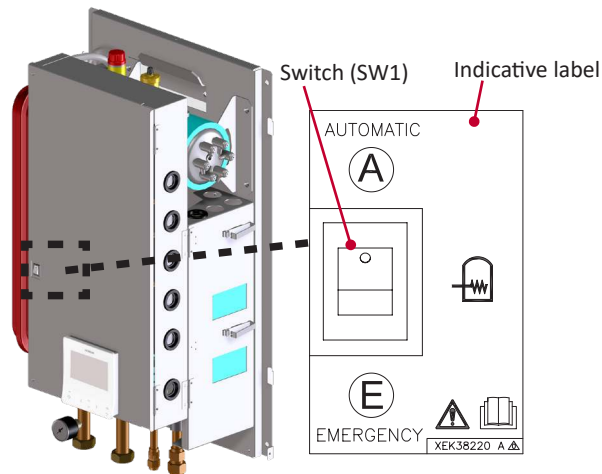

### ◆ Remove the electrical box cover

- 1 Remove the indoor unit service cover as explained above.
- 2 Unscrew the 2 front screws of the electrical box cover and then, rotate it.

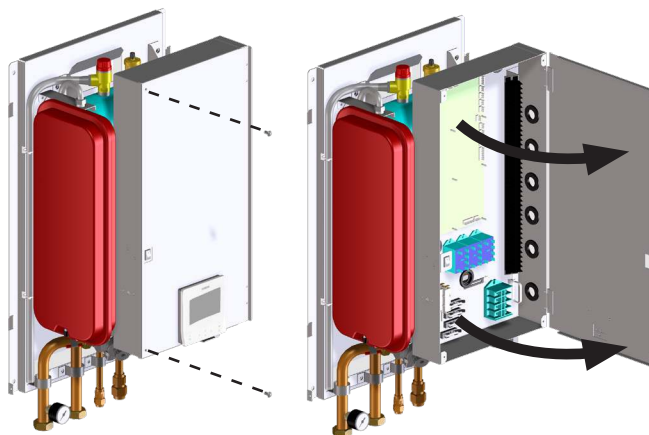

### CAUTION

*Take care with the electrical box components in order to avoid damaging it.*

## 7.3 Space heating pipes connection

The unit is factory supplied with two shut-off valves which have to be connected to the water inlet / outlet connections. With these shut-off valves it is very practical to connect the indoor unit to the heating system by using the factory supplied gaskets just below the valves. Then, the space heating installation can be carried out.

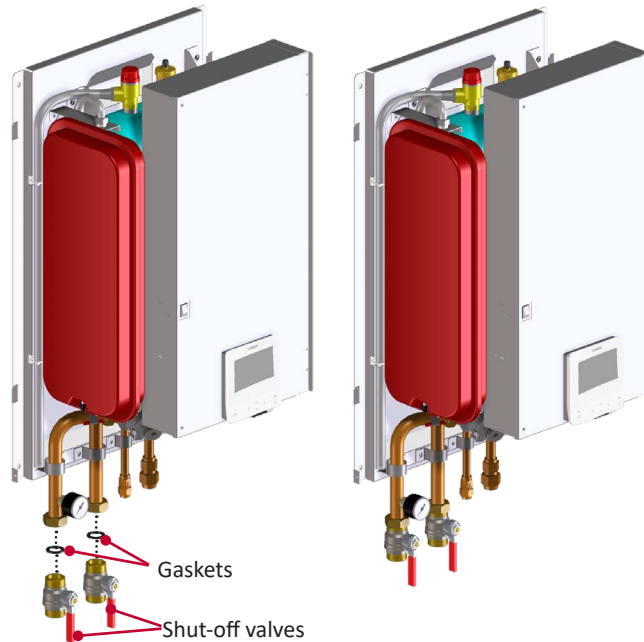

## 7.4 Drain pipes connection

For a correct drainage, connect the drain pipe for the safety valve to the general draining system.

### NOTE

- *The safety valve is activated when water pressure reaches 3 bars.*
- *Drain taps must be provided at all low points of the installation to permit complete drainage of the circuit during servicing.*

## 7.5 Cover assembly

- 1 Place the indoor unit service cover at the same level of the wall mounted unit by taking it from the bottom side (one person can perform this operation, during this operation it is possible to rest the cover on the electrical box).



- 2 Place the holes on the right side of the indoor unit cover over the back plate hooks (x2 locations). When the right side is centred, repeat the operation on the left side. Put the holes on the left side of the indoor unit cover into the back plate frame hooks (x2 locations).

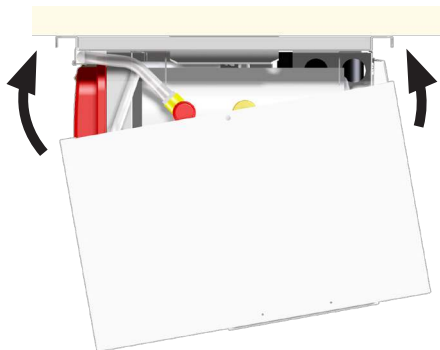

- 3 Once the 4 hooks are placed into their corresponding cover holes, adjust the cover to the end of the hooks.



- 4 Fix the indoor unit service cover using the screw which had been previously removed during the unpacking procedure.

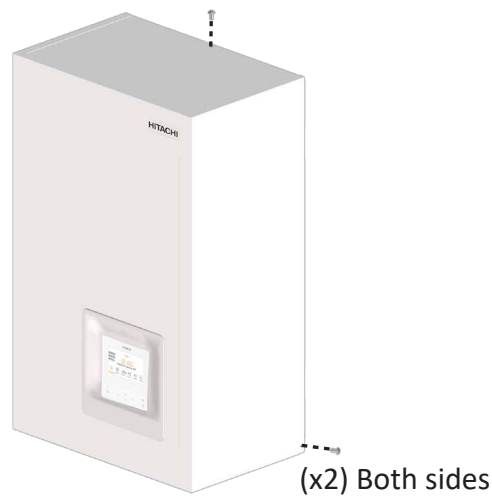

## 7.6 Test and check

Finally, test and check the following items:

- Water leakage
- Refrigerant leakage
- Electrical connection
- ...

### NOTE

Please refer to the chapters of “5.5 Refrigerant charge”, “5.6.3.1 Water filling” and “Commissioning” in this document and refer the Outdoor unit Installation and Operation manual for the specific details about refrigerant charge tasks.

### DANGER

**Do not connect the power supply to the indoor unit prior to filling the space heating circuit (and DHW circuit if it were the case) with water and checking water pressure and the total absence of any water leakage.**



## Commissioning

8.1	Before operation.....	78
8.2	Preliminary check .....	78
8.2.1	Checking the unit.....	78
8.2.2	Electrical checking .....	78
8.2.3	Hydraulic circuit checking (space heating and DHW) .....	79
8.2.4	Checking the refrigerant circuit.....	80
8.3	Commissioning procedure .....	80
8.3.1	Commissioning from unit controller .....	81
8.3.1.1	Screed drying function .....	83
8.3.2	NFC Tap Function.....	83

## 8.1 Before operation

### CAUTION

- Supply electrical power to the system for approximately 12 hours before start-up after a long shut-off. Do not start the system immediately after power supply, it may cause compressor failure because the compressor is not well-heated.
- When the system is started after a shut-off longer than approximately 3 months, it is recommended that the system be checked by your service contractor.
- Turn OFF the main switch when the system is to be stopped for a long period of time: as the oil heater is always energized even when the compressor is not working, there will be electricity consumption unless the main switch is turned OFF.

## 8.2 Preliminary check

When installation is complete, perform commissioning according to the following procedure, and hand over the system to the customer. Perform the commissioning of the units methodically, and check that the electrical wiring and the piping are correctly connected.

Indoor and outdoor units must be configured by the installer to get the perfect setting and the unit working.

### NOTE

*For the commissioning of the outdoor unit please refer to the outdoor unit installation and operation manual.*

### 8.2.1 Checking the unit

- Check external appearance of the unit to look for any damage due to transportation or installation.
- Check that all the covers are totally closed.
- Check that the recommended service space is respected (see *Service space* chapter in the Indoor unit Instruction manual and the outdoor unit Installation and operation manual).
- Check that the unit has been correctly installed onto the wall.

### 8.2.2 Electrical checking

#### CAUTION

*Do not operate the system until all the check points have been cleared:*

- *Check to ensure that the electrical resistance is more than 1 MΩ, by measuring the resistance between ground and electrical parts terminal. If not, do not operate the system until the electrical leakage is found and repaired. Do not impress the voltage on the terminals for transmission and sensors.*

- Check to ensure that the switch on the main power source has been ON for more than 12 hours, in order to give the oil heater time to warm the compressor.
- In three-phase unit check phase sequence connection on terminal board.
- Check the power supply voltage ( $\pm 10\%$  of the rated voltage).
- Check that field-supplied electrical components (main switches, breakers, wires, conduit connectors and wire terminals) have been properly selected according to the electrical specifications given in this document, and check that the components comply with national and local standards.
- Do not touch any electrical components for more than three minutes after turning OFF the main switch.
- Check the dip switch settings of the indoor unit and the outdoor unit are connected as shown in the corresponding chapter.
- Check to ensure the electrical wiring of the indoor unit and the outdoor unit are connected as shown in the chapter.
- Check to ensure the external wiring is correctly fixed. To avoid problems with vibrations, noises and cut out wires with the plates.

## 8.2.3 Hydraulic circuit checking (space heating and DHW)

- Check that the circuit has been properly flushed and filled with water and that the installation has been drained: the pressure of the heating circuit must be 1.8 bar.
- Check for any leakage in water cycle. Pay special attention to the water piping connections.
- Make sure the system's internal water volume is correct.
- Check that the hydraulic circuit's valves are fully open.
- Check to see that electrical heater is completely filled with water by operating pressure of safety valve.
- Check to see that additional water pumps (WP2 or/and WP3) are correctly connected to terminal board.

### CAUTION

- Operating the system with closed valves will damage the unit.
- Check to see that air purge valve is open and that the hydraulic circuit is air purged. The installer is responsible of completely air purging the installation.
- Check that the water pump of the space heating circuit works within the pump operating range and that the water flow is over the pump's minimum. If the water flow is under 12 litres/minute for 4.0-10.0HP (6 litres/minute for 2.0/2.5/3.0HP unit) (with flow switch tolerance), alarm will be displayed on the unit.
- Remember that water connection must be accordance with local regulations.
- Water quality must comply with EU directive 98/83 EC.
- Electrical heater operation when not completely filled with water will damage the heater.



## 8.2.4 Checking the refrigerant circuit

- Check to ensure that the stop valves on the gas and liquid lines are fully open.
- Check that the size of the piping and the refrigerant charge comply with the applicable recommendations.
- Check the inside of the unit for refrigerant leakage. If there is a refrigerant leak, call your dealer.
- Check outdoor unit commissioning procedure manual.

## 8.3 Commissioning procedure

This procedure is valid regardless of what options are on the module.

- When installation is complete and all necessary settings (Dip-switches in PCBs and user controller configuration) have been carried out, close the electrical box and place the cabinet as shown in the manual.
- Make the start-up wizard configuration in the user controller.
- Make a test run as shown in item *“8.3.1 Commissioning from unit controller”*.
- After test run is completed, start the entire unit or the selected circuit by pressing the OK button.

### ◆ Initial start-up at low outdoor ambient temperatures

During commissioning and when water temperature is very low, it is important for the water to be heated gradually. Additional optional function can be used for starting at low water temperature conditions:

#### CAUTION

- *Heating at lower water temperatures (approximately 10°C to 15°C) and lower outdoor ambient temperatures (<10°C) can be damaging to the heat pump when defrosting.*
- *As a result, Heating up to 15°C when outdoor temperature is lower than 10°C is performed by the Electrical Heater.*

#### NOTE

*In case of Heater Forced OFF (by optional dip switch setting) these condition is not performed and heating is performed by Heat Pump. Hitachi is not responsible for its operation.*

#### CAUTION

*It is recommended start the unit (first power ON) with heater forced OFF and compressor forced OFF (See *“6.3 Setting of DIP switches and RSW switches”*). In order to circulate water by water pump and remove possible air into the heater (Check heater completely filled).*

## 8.3.1 Commissioning from unit controller

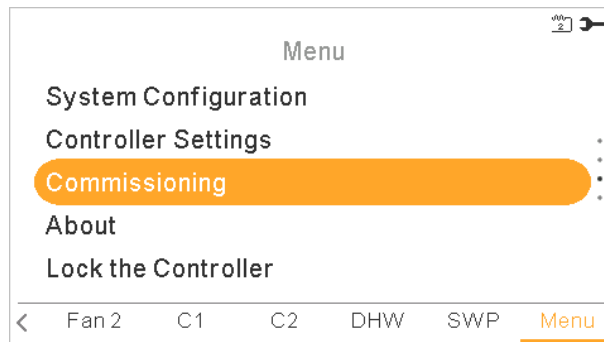

This menu shows the following test to be launched:

- Air Purge Procedure: Air purge function drives the pump in a way for evacuating air bubbles in the installation.
- Unit Test Run: Test run is a working mode used when commissioning the installation. Some settings are made to let the installer an easy job.
- Pump down procedure: Pump down is used to remove the refrigerant from the system, typically for maintenance or shutdown.
- Screed Drying: The screed function is used exclusively for the process of drying a newly applied screed to the floor heating system.

After “Test Run”, “Air Purge” or “Pump down procedure” option is selected, the **airH2O 600** user controller asks for the duration of the test.

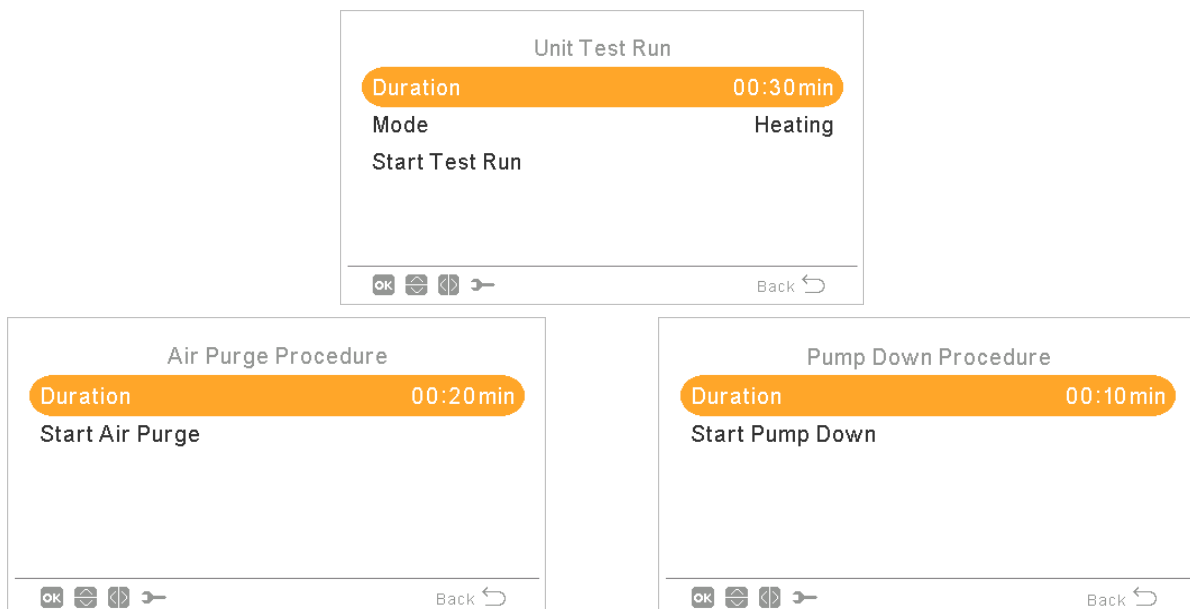

In case of test run, user can also select the mode of the test (cooling or heating).

When user confirms the test run or the air purge, the **airH2O 600** user controller sends the order to the indoor.

During the execution of this test, the following screen is shown:

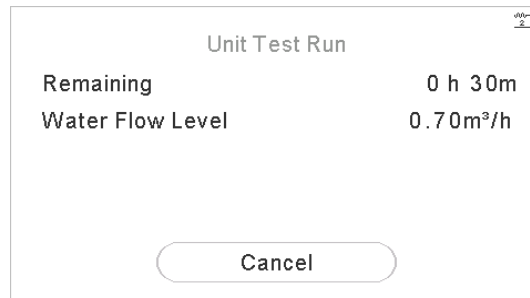

- When the test starts, the user controller will exit from the installer mode.
- User can cancel the test run regardless of the time left for test finishing.
- The Test Run icon is shown in the notifications zone, but the notification of this test run is taken from H-LINK.

When test run has finished, an information message is displayed in the screen, and pressing accept, the user returns to the global view.

## NOTE

- *When commissioning and installing the unit, it is very important to use the “Air purge” function to remove all the air in the water circuit. When the air purge function is running, the water pump starts the automatic air venting routine which consists of regulating the speed and open/close configured 3-way valve to help to evacuate air from the system.*
- *For Outdoor test run, refer to Outdoor Unit Installation Manual.*
- *If there is a Heater or a Boiler installed, disable the operation before running the test run.*

## 8.3.1.1 Screed drying function

The screed function is used exclusively for the process of drying a newly applied screed to the floor heating system. The process is based on EN-1264 par 4.

Users can activate the screed function in either standard or custom mode:

### ◆ Standard mode

- 1 Phase 1 settings (by default): water set point is kept constant at 25°C for 3 days.
- 2 Phase 2 settings: water set-point is set to the maximum heating supply temperature (but always limited to ≤ 60°C) for 4 days.

### ◆ Custom mode

- 1 Phase 1 settings :
  - ✓ Duration: select the duration of the phase 1 from 3 to 6 days.
  - ✓ Mode: Lineal or Fix:
    - Fix: the water set point is kept constant at the selected temperature in desired setting menu (between 20 to 25°C).
    - Lineal: the water set point keeps going up from the initial setting to the desired setting selected (between 20 to 25°C).
- 2 Phase 2 settings:
  - ✓ Duration: select the duration of the phase 2 from 4 to 8 days.
  - ✓ Mode: Lineal or Fix:
    - Fix: the water set point is kept constant at the selected temperature in desired setting menu (between 20 to 60°C).
    - Lineal: the water set point keeps going up from the initial setting to the desired setting selected (between 20 to 60°C) .

## 8.3.2 NFC Tap Function

Configuring the **airH2O 600** unit using NFC Tap mobile device is possible. Download the CSNET Home application from the Apple Store or Google Play Store. The application is also available at [www.csnetmanager.com](http://www.csnetmanager.com). Follow the instructions within the app to connect the unit.



*Google Play and the Google Play logo are trademarks of Google LLC.*

*Apple and the Apple logo are trademarks of Apple Inc., registered in the U.S. and other countries. App Store is a service mark of Apple Inc.*



## ERP Data

9.1	AVERAGE climate .....	85
9.2	WARMER climate .....	88
9.3	COLDER climate .....	89
9.4	Additional data .....	90
9.5	General ERP data for hot water storage tanks .....	91

## 9.1 AVERAGE climate

		HP		1.5 HP		2.0 HP		2.5 HP		3.0 HP	
		Outdoor unit		RAS-1.5WH(V)RP2E		RAS-2WH(V)RP2E		RAS-2.5WH(V)RP2E		RAS-3WH(V)RP2E	
		Indoor unit		RWM-1.5R3E		RWM-2.0R3E		RWM-2.5R3E		RWM-3.0R3E	
		Water outlet temperature		RWD-1.5RW3E-220S(-K)		RWD-2.0RW3E-220S(-K)		RWD-2.5RW3E-220S(-K)		RWD-3.0RW3E-220S(-K)	
				35°C	55°C	35°C	55°C	35°C	55°C	35°C	55°C
Product description	Air to water heat pump	-	Yes	Yes	Yes	Yes	Yes	Yes	Yes	Yes	Yes
	Heat pump combination heater	-	No	No	No	No	No	No	No	No	No
	Low temperature heat pump	-	No	No	No	No	No	No	No	No	No
	Complementary heater	-	Yes	Yes	Yes	Yes	Yes	Yes	Yes	Yes	Yes
Design capacity ( $P_{DESIGN}$ )		kW	3.5	3.5	4	4	6	5	7	6	
Nominal energy efficiency ( $\eta_s$ )		%	175 (180)	125 (127)	175 (179)	125 (127)	175 (178)	126 (128)	175 (177)	125 (127)	
SCOP		-	4.45 (4.57)	3.19 (3.26)	4.44 (4.55)	3.19 (3.24)	4.44 (4.51)	3.23 (3.28)	4.44 (4.51)	3.20 (3.24)	
Nominal energy class		-	A+++	A++	A+++	A++	A+++	A++	A+++	A++	
Data for Packaged Fiche	Energy efficiency with OTC control ( $\eta_s$ ) (*)	%	177 (182)	127 (129)	177 (181)	127 (129)	177 (180)	128 (130)	177 (179)	127 (129)	
	Energy class with OTC control	-	A+++	A++	A+++	A++	A+++	A++	A+++	A++	
	Energy efficiency with thermostats/sensors ( $\eta_s$ ) (*)	%	179 (184)	129 (131)	179 (183)	129 (131)	179 (182)	130 (132)	179 (181)	129 (131)	
	Energy class with thermostats	-	A+++	A++	A+++	A++	A+++	A++	A+++	A++	
Supplementary capacity ( $P_{SUP}$ )		kW	0	0	0	0.9	0.7	1.1	1.4	1	
Type of energy used		-	Electricity	Electricity	Electricity	Electricity	Electricity	Electricity	Electricity	Electricity	
Declared capacity (Pdh) and coefficient of performance (COP <sub>d</sub> ) at partial load under the following outdoor temperatures	Outdoor temperature (Tj) = -7°C	Pdh	kW	3.1	3.1	3.54	3.4	5.1	4.42	5.9	5.1
		COP <sub>d</sub>	-	2.85	2.1	2.87	2.18	2.5	1.85	2.7	1.85
	Outdoor temperature (Tj) = +2°C	Pdh	kW	2	2	2.35	2.1	3.1	2.69	3.59	3.1
		COP <sub>d</sub>	-	4.55	3.05	4.43	2.9	4.45	3.15	4.3	3.05
	Outdoor temperature (Tj) = +7°C	Pdh	kW	3	2.43	3	2.43	3	2.43	3.2	2
		COP <sub>d</sub>	-	6.8	4.85	7	5.19	6.6	4.8	6.6	4.7
	Outdoor temperature (Tj) = +12°C	Pdh	kW	3.05	2.8	3.05	2.8	3.05	2.8	3.5	2.2
		COP <sub>d</sub>	-	7.81	7	7.95	7.07	8.89	6.8	9.7	7.4
	Outdoor temperature (Tj) = Bivalent temperature (T <sub>biv</sub> )	Pdh	kW	3.1	3.1	3.54	3.5	5.1	4.42	5.9	5.1
		COP <sub>d</sub>	-	2.85	2.1	2.87	2.18	2.5	1.85	2.7	1.85
	Outdoor temperature (Tj) = Limit operation temperature (TOL)	Pdh	kW	3.5	3.5	4	3.1	5.3	3.9	5.6	5
		COP <sub>d</sub>	-	2.58	2.55	2.75	1.9	2.5	1.7	2.3	1.5
Bivalent temperature (T <sub>biv</sub> )		°C	-7	-7	-7	-7	-7	-7	-7	-7	
Limit operation temperature (TOL)		°C	-10	-10	-10	-10	-10	-10	-10	-10	
Water limit operation temperature (WTOL)		°C	55	55	55	55	55	55	55	55	
Degradation coefficient (Cdh)		-	0.9	0.9	0.9	0.9	0.9	0.9	0.9	0.9	
Annual energy consumption (Q <sub>HE</sub> )		kW·h	1576 (1532)	2414 (2370)	1862 (1818)	2563 (2520)	2682 (2638)	3192 (3149)	3101 (3057)	3718 (3674)	

HP		3.5 HP		4.0 HP		5.0 HP		6.0 HP			
		Outdoor unit		RAS-3.5WH(V)RP2E		RAS-5WH(V)RP2E		RAS-3.5WH(V)RP2E		RAS-5WH(V)RP2E	
Indoor unit		RWM-3.5R3E		RWM-4.0R3E		RWM-5.0R3E		RWM-6.0R3E			
		RWD-3.5RW3E-220S(-K)		RWD-4.0RW3E-220S(-K)		RWD-5.0RW3E-220S(-K)		RWD-6.0RW3E-220S(-K)			
Water outlet temperature		35°C	55°C	35°C	55°C	35°C	55°C	35°C	55°C		
Product description	Air to water heat pump	-	Yes	Yes	Yes	Yes	Yes	Yes	Yes		
	Heat pump combination heater	-	No	No	No	No	No	No	No		
	Low temperature heat pump	-	No	No	No	No	No	No	No		
	Complementary heater	-	Yes	Yes	Yes	Yes	Yes	Yes	Yes		
Design capacity (P <sub>DESIGN</sub> )		kW	12.1	12.1	12.1	12.1	13	14	13	14	
Nominal energy efficiency (η <sub>s</sub> )		%	177 (178)	129 (129)	177 (178)	129 (129)	176 (178)	127 (128)	176 (178)	127 (128)	
SCOP		-	4.49 (4.54)	3.29 (3.31)	4.49 (4.54)	3.29 (3.31)	4.48 (4.52)	3.26 (3.28)	4.48 (4.52)	3.26 (3.28)	
Nominal energy class		-	A+++	A++	A+++	A++	A+++	A++	A+++	A++	
Data for Packaged Fiche	Energy efficiency with OTC control (η <sub>s</sub> ) (*)	%	179 (180)	131 (131)	179 (180)	131 (131)	178 (180)	129 (130)	178 (180)	129 (130)	
	Energy class with OTC control	-	A+++	A++	A+++	A++	A+++	A++	A+++	A++	
	Energy efficiency with thermostats/sensors (η <sub>s</sub> ) (*)	%	181 (182)	133 (133)	181 (182)	133 (133)	180 (182)	131 (132)	180 (182)	131 (132)	
	Energy class with thermostats	-	A+++	A++	A+++	A++	A+++	A++	A+++	A++	
Supplementary capacity (P <sub>SUP</sub> )		kW	0	1.5	0	1.5	0	1.6	0	1.6	
Type of energy used		-	Electricity	Electricity	Electricity	Electricity	Electricity	Electricity	Electricity	Electricity	
Declared capacity (P <sub>d</sub> ) and coefficient of performance (COP <sub>d</sub> ) at partial load under the following outdoor temperatures	Outdoor temperature (T <sub>j</sub> ) = -7°C	P <sub>d</sub>	kW	10.7	10.7	10.7	10.7	11.5	12.4	11.5	12.4
		COP <sub>d</sub>	-	2.96	2.15	2.96	2.15	2.91	2.09	2.91	2.09
	Outdoor temperature (T <sub>j</sub> ) = +2°C	P <sub>d</sub>	kW	6.51	6.51	6.51	6.51	7	7.55	7	7.55
		COP <sub>d</sub>	-	4.2	3.06	4.2	3.06	4.35	3.1	4.35	3.1
	Outdoor temperature (T <sub>j</sub> ) = +7°C	P <sub>d</sub>	kW	4.19	4.19	4.19	4.19	4.5	4.85	4.5	4.85
		COP <sub>d</sub>	-	6.13	4.56	6.13	4.56	5.82	4.34	5.82	4.34
	Outdoor temperature (T <sub>j</sub> ) = +12°C	P <sub>d</sub>	kW	3.99	3.65	3.99	3.65	4.1	4.23	4.1	4.23
		COP <sub>d</sub>	-	8.62	6.26	8.62	6.26	8.04	6.36	8.04	6.36
	Outdoor temperature (T <sub>j</sub> ) = Bivalent temperature (T <sub>biv</sub> )	P <sub>d</sub>	kW	10.7	10.7	10.7	10.7	11.5	12.4	11.5	12.4
		COP <sub>d</sub>	-	2.96	2.15	2.96	2.15	2.91	2.09	2.91	2.09
	Outdoor temperature (T <sub>j</sub> ) = Limit operation temperature (TOL)	P <sub>d</sub>	kW	12.1	10.6	12.1	10.6	13.0	12.4	13.0	12.4
		COP <sub>d</sub>	-	2.89	2.02	2.89	2.02	2.59	1.86	2.59	1.86
Bivalent temperature (T <sub>biv</sub> )		°C	-7	-7	-7	-7	-7	-7	-7	-7	
Limit operation temperature (TOL)		°C	-10	-10	-10	-10	-10	-10	-10	-10	
Water limit operation temperature (WTOL)		°C	55	55	55	55	55	55	55	55	
Degradation coefficient (C <sub>dh</sub> )		-	0.9	0.9	0.9	0.9	0.9	0.9	0.9	0.9	
Annual energy consumption (Q <sub>HE</sub> )		kW·h	5561 (5508)	7600 (7548)	5561 (5508)	7600 (7548)	5991 (5939)	8886 (8834)	5991 (5939)	8886 (8834)	

		HP	8.0 HP		10.0 HP		
		Outdoor unit	RAS-8WHNPE		RAS-10WHNPE		
		Indoor unit	RWM-8.0N3E		RWM-10.0N3E		
		Water outlet temperature	35°C	55°C	35°C	55°C	
Product description	Air to water heat pump	-	Yes	Yes	Yes	Yes	
	Heat pump combination heater	-	No	No	No	No	
	Low temperature heat pump	-	No	No	No	No	
	Complementary heater	-	Yes	Yes	Yes	Yes	
Design capacity ( $P_{DESIGN}$ )	kW	18	16	20	18		
Nominal energy efficiency ( $\eta_s$ )	%	150 (152)	120 (122)	141 (142)	116 (118)		
SCOP	-	3.83 (3.88)	3.08 (3.13)	3.60 (3.63)	2.98 (3.03)		
Nominal energy class	-	A++	A+	A+	A+		
Data for Packaged Fiche	Energy efficiency with OTC control ( $\eta_s$ ) (*)	%	152 (154)	122 (124)	143 (144)	118 (120)	
	Energy class with OTC control	-	A++	A+	A+	A+	
	Energy efficiency with thermostats/sensors ( $\eta_s$ ) (*)	%	153 (155)	123 (125)	144 (145)	119 (121)	
	Energy class with thermostats	-	A++	A+ (A++)	A+	A+	
Supplementary capacity ( $P_{SUP}$ )	kW	2	3.9	2	4		
Type of energy used	-	Electricity	Electricity	Electricity	Electricity		
Declared capacity (Pd <sub>h</sub> ) and coefficient of performance (COP <sub>d</sub> ) at partial load under the following outdoor temperatures	Outdoor temperature (T <sub>j</sub> ) = -7°C	Pd <sub>h</sub>	kW	15.6	13.8	17.4	15.6
		COP <sub>d</sub>	-	2.5	1.65	2.3	1.65
	Outdoor temperature (T <sub>j</sub> ) = +2°C	Pd <sub>h</sub>	kW	9.5	8.4	10.77	9.5
		COP <sub>d</sub>	-	3.85	3.1	3.6	3.1
	Outdoor temperature (T <sub>j</sub> ) = +7°C	Pd <sub>h</sub>	kW	6.1	6	8.7	8.3
		COP <sub>d</sub>	-	5.4	4.76	5.1	4.35
	Outdoor temperature (T <sub>j</sub> ) = +12°C	Pd <sub>h</sub>	kW	7	6.8	8.7	8.5
		COP <sub>d</sub>	-	4.65	5.1	4.9	4.6
	Outdoor temperature (T <sub>j</sub> ) = Bivalent temperature (T <sub>biv</sub> )	Pd <sub>h</sub>	kW	15.6	13.8	17.4	15.6
		COP <sub>d</sub>	-	2.5	1.65	2.3	1.65
	Outdoor temperature (T <sub>j</sub> ) = Limit operation temperature (TOL)	Pd <sub>h</sub>	kW	16	12.1	18	14
		COP <sub>d</sub>	-	2.4	1.5	2.1	1.45
Bivalent temperature (T <sub>biv</sub> )	°C	-7	-7	-7	-7		
Limit operation temperature (TOL)	°C	-10	-10	-10	-10		
Water limit operation temperature (WTOL)	°C	55	55	55	55		
Degradation coefficient (Cdh)	-	0.9	0.9	0.9	0.9		
Annual energy consumption (Q <sub>HE</sub> )	kW·h	9513 (9382)	10452 (10320)	11410 (11278)	12210 (12078)		



## 9.2 WARMER climate

		HP	1.5 HP	2.0 HP	2.5 HP	3.0 HP
		Outdoor unit	RAS-1.5WH(V)RP2E	RAS-2WH(V)RP2E	RAS-2.5WH(V)RP2E	RAS-3WH(V)RP2E
		Indoor unit	RWM-1.5R3E	RWM-2.0R3E	RWM-2.5R3E	RWM-3.0R3E
			RWD-1.5RW3E-220S(-K)	RWD-2.0RW3E-220S(-K)	RWD-2.5RW3E-220S(-K)	RWD-3.0RW3E-220S(-K)
Design capacity ( $P_{DESIGN}$ )	kW		3.5	4	5	6
Nominal energy efficiency ( $\eta_s$ )	%		172 (181)	185 (194)	165 (171)	170 (175)
SCOP	-		4.38 (4.60)	4.69 (4.92)	4.19 (4.34)	4.33 (4.46)
Data for packaged fiche	Energy efficiency with OTC control ( $\eta_s$ ) (*)	%	175 (185)	189 (198)	168 (174)	173 (178)
	Energy efficiency with thermostats ( $\eta_s$ ) (*)	%	179 (188)	192 (202)	172 (178)	177 (182)
Annual energy consumption ( $Q_{HE}$ )	kW·h		1068 (1016)	1139 (1087)	1593 (1540)	1851 (1799)

		HP	3.5 HP	4.0 HP	5.0 HP	6.0 HP
		Outdoor unit	RAS-3.5WH(V)RP2E	RAS-4WH(V)RP2E	RAS-5WH(V)RP2E	RAS-6WH(V)RP2E
		Indoor unit	RWM-3.5R3E	RWM-4.0R3E	RWM-5.0R3E	RWM-6.0R3E
			RWD-3.5RW3E-220S(-K)	RWD-4.0RW3E-220S(-K)	RWD-5.0RW3E-220S(-K)	RWD-6.0RW3E-220S(-K)
Design capacity ( $P_{DESIGN}$ )	kW		12.1	12.1	14	14
Nominal energy efficiency ( $\eta_s$ )	%		167 (170)	167 (170)	167 (170)	167 (170)
SCOP	-		4.26 (4.33)	4.26 (4.33)	4.26 (4.33)	4.26 (4.33)
Data for packaged fiche	Energy efficiency with OTC control ( $\eta_s$ ) (*)	%	169 (172)	169 (172)	169 (172)	169 (172)
	Energy efficiency with thermostats ( $\eta_s$ ) (*)	%	171 (174)	171 (174)	171 (174)	171 (174)
Annual energy consumption ( $Q_{HE}$ )	kW·h		3796 (3734)	3796 (3734)	4394 (4333)	4394 (4333)

		HP	8.0 HP	10.0 HP
		Outdoor unit	RAS-8WHNPE	RAS-10WHNPE
		Indoor unit	RWM-8.0N3E	RWM-10.0N3E
Design capacity ( $P_{DESIGN}$ )	kW		16	18
Nominal energy efficiency ( $\eta_s$ )	%		178 (181)	173 (178)
SCOP	-		4.53 (4.6)	4.4 (4.53)
Data for packaged fiche	Energy efficiency with OTC control ( $\eta_s$ ) (*)	%	180 (183)	175 (180)
	Energy efficiency with thermostats ( $\eta_s$ ) (*)	%	181 (184)	176 (181)
Annual energy consumption ( $Q_{HE}$ )	kW·h		4725 (4641)	5466 (5307)

## 9.3 COLDER climate

		HP	1.5 HP	2.0 HP	2.5 HP	3.0 HP
		Outdoor unit	RAS-1.5WH(V)RP2E	RAS-2WH(V)RP2E	RAS-2.5WH(V)RP2E	RAS-3WH(V)RP2E
		Indoor unit	RWM-1.5R3E	RWM-2.0R3E	RWM-2.5R3E	RWM-3.0R3E
			RWD-1.5RW3E-220S(-K)	RWD-2.0RW3E-220S(-K)	RWD-2.5RW3E-220S(-K)	RWD-3.0RW3E-220S(-K)
Design capacity ( $P_{DESIGN}$ )		kW	3.5	4	5	6
Nominal energy efficiency ( $\eta_s$ )		%	110 (111)	112 (113)	106 (107)	113 (113)
SCOP		-	2.84 (2.86)	2.88 (2.90)	2.74 (2.75)	2.90 (2.91)
Data for packaged fiche	Energy efficiency with OTC control ( $\eta_s$ ) (*)	%	112 (113)	115 (116)	108 (109)	115 (115)
	Energy efficiency with thermostats ( $\eta_s$ ) (*)	%	114 (115)	117 (118)	110 (111)	118 (118)
Annual energy consumption ( $Q_{HE}$ )		kW·h	3195 (3169)	3359 (3333)	4640 (4613)	5110 (5024)

		HP	3.5 HP	4.0 HP	5.0 HP	6.0 HP
		Outdoor unit	RAS-3.5WH(V)RP2E	RAS-4WH(V)RP2E	RAS-5WH(V)RP2E	RAS-6WH(V)RP2E
		Indoor unit	RWM-3.5R3E	RWM-4.0R3E	RWM-5.0R3E	RWM-6.0R3E
			RWD-3.5RW3E-220S(-K)	RWD-4.0RW3E-220S(-K)	RWD-5.0RW3E-220S(-K)	RWD-6.0RW3E-220S(-K)
Design capacity ( $P_{DESIGN}$ )		kW	12.1	12.1	14	14
Nominal energy efficiency ( $\eta_s$ )		%	106 (106)	106 (106)	104 (106)	104 (106)
SCOP		-	2.71 (2.73)	2.71 (2.73)	2.67 (2.68)	2.67 (2.68)
Data for packaged fiche	Energy efficiency with OTC control ( $\eta_s$ ) (*)	%	108 (108)	108 (108)	106 (108)	106 (108)
	Energy efficiency with thermostats ( $\eta_s$ ) (*)	%	110 (110)	110 (110)	108 (110)	108 (110)
Annual energy consumption ( $Q_{HE}$ )		kW·h	9241 (9189)	9241 (9189)	10820 (10768)	10820 (10768)

		HP	8.0 HP	10.0 HP
		Outdoor unit	RAS-8WHNPE	RAS-10WHNPE
		Indoor unit	RWM-8.0N3E	RWM-10.0N3E
Design capacity ( $P_{DESIGN}$ )		kW	16	18
Nominal energy efficiency ( $\eta_s$ )		%	109 (110)	107 (107)
SCOP		-	2.8 (2.83)	2.75 (2.75)
Data for packaged fiche	Energy efficiency with OTC control ( $\eta_s$ ) (*)	%	111 (113)	109 (109)
	Energy efficiency with thermostats ( $\eta_s$ ) (*)	%	112 (114)	110 (110)
Annual energy consumption ( $Q_{HE}$ )		kW·h	13987 (13945)	15956 (15876)

## 9.4 Additional data

	HP	1.5 HP	2.0 HP	2.5 HP	3.0 HP
	Outdoor unit	RAS-1.5WH(V)RP2E	RAS-2WH(V)RP2E	RAS-2.5WH(V)RP2E	RAS-3WH(V)RP2E
	Indoor unit	RWM-1.5R3E RWD-1.5RW3E-220S(-K)	RWM-2.0R3E RWD-2.0RW3E-220S(-K)	RWM-2.5R3E RWD-2.5RW3E-220S(-K)	RWM-3.0R3E RWD-3.0RW3E-220S(-K)
Electrical power input in stand-by mode (Psb)	W	11.9	11.9	11.9	11.9
Electrical power input in thermostat-OFF mode (Pto)	W	0	0	0	0
Electrical power input in OFF mode (Poff)	W	11.9	11.9	11.9	11.9
Electrical power input in crankcase heater mode (Pck)	W	0	0	0	0
Sound power level of indoor unit (Lwa)	dB(A)	41	41	41	41
Sound power level of outdoor unit (Lwa)	dB(A)	50	50	51	51
Capacity control mode	-	Variable (Inverter)	Variable (Inverter)	Variable (Inverter)	Variable (Inverter)
Integrated supplementary heater	kW	3	3	3	3
Nominal outdoor air flow	m <sup>3</sup> /h	2436	2436	2682	2682

	HP	3.5 HP	4.0 HP	5.0 HP	6.0 HP
	Outdoor unit	RAS-3.5WH(V)RP2E	RAS-4WH(V)RP2E	RAS-5WH(V)RP2E	RAS-6WH(V)RP2E
	Indoor unit	RWM-3.5R3E RWD-3.5RW3E-220S(-K)	RWM-4.0R3E RWD-4.0RW3E-220S(-K)	RWM-5.0R3E RWD-5.0RW3E-220S(-K)	RWM-6.0R3E RWD-6.0RW3E-220S(-K)
Electrical power input in stand-by mode (Psb)	W	14	14	14	14
Electrical power input in thermostat-OFF mode (Pto)	W	15	15	15	15
Electrical power input in OFF mode (Poff)	W	14	14	14	14
Electrical power input in crankcase heater mode (Pck)	W	0	0	0	0
Sound power level of indoor unit (Lwa)	dB(A)	41	41	41	41
Sound power level of outdoor unit (Lwa)	dB(A)	53	53	54	54
Capacity control mode	-	Variable (Inverter)	Variable (Inverter)	Variable (Inverter)	Variable (Inverter)
Integrated supplementary heater	kW	6	6	6	6
Nominal outdoor air flow	m <sup>3</sup> /h	6409	6409	6894	6894

	HP	8.0 HP	10.0 HP
	Outdoor unit	RAS-8WHNPE	RAS-10WHNPE
	Indoor unit	RWM-8.0N3E	RWM-10.0N3E
Electrical power input in stand-by mode (Psb)	W	36	36
Electrical power input in thermostat-OFF mode (Pto)	W	0	0
Electrical power input in OFF mode (Poff)	W	36	36
Electrical power input in crankcase heater mode (Pck)	W	0	0
Sound power level of indoor unit (Lwa)	dB(A)	47	47
Sound power level of outdoor unit (Lwa)	dB(A)	59	60
Capacity control mode	-	Variable (inverter)	Variable (inverter)
Integrated supplementary heater	kW	9	9
Nominal outdoor air flow	m <sup>3</sup> /h	7620	8040

## 9.5 General ERP data for hot water storage tanks

Model		DHWT-200S-3.0H2E	DHWT-300S-3.0H2E
Storage volume	l	194	264
Standing loss	W	47.3	62.8
Energy efficiency class	-	B	B



Johnson Controls-Hitachi Air Conditioning Spain, S.A.U.  
Ronda Shimizu, 1 - Políg. Ind. Can Torrella  
08233 Vacarisses (Barcelona) Spain

© Copyright 2025 Johnson Controls-Hitachi Air Conditioning Spain, S.A.U. – All rights reserved.