

**AXE 50.0~60.0H-1HT-S1 High Voltage  
Battery System User Manual**

## About This Document

This document introduces the AXE 50.0~60.0H-1HT-S1 High Voltage Battery System in terms of its installation, electrical connection, operation, commission, maintenance, and troubleshooting. Before installing and operating the AXE system, ensure that you are familiar with the product features, functions, and safety precautions provided in this document.

Symbol	Description
 <b>WARNING</b>	Indicates a potentially hazardous situation, if not avoided, could result in serious injury or death.

## Change history

Version 00

First release

# Table of Contents

<b>1 Product Overview .....</b>	<b>1</b>
1.1 Intended Use .....	1
1.2 Appearance.....	1
1.2.1 Battery Cabinet .....	1
1.2.2 Intra-cabinet Components .....	3
1.2.3 AXE 1000100-C1 (Control Module).....	4
1.2.4 AXE 5.0H-E1 EU (Battery Module).....	5
1.3 Working Principle and Function .....	6
<b>2 Safety .....</b>	<b>7</b>
2.1 Basic Security.....	7
2.2 Safety Precautions .....	7
2.2.1 Environment Requirements .....	7
2.2.2 Operation Precautions .....	8
2.3 Warning Labels.....	8
2.4 Emergency Responses .....	11
<b>3 Storage and Transportation .....</b>	<b>12</b>
3.1 Storage Requirements.....	12
3.2 Transportation Requirements .....	13
<b>4 Installation.....</b>	<b>14</b>
4.1 Installation Environment .....	14
4.2 Basic Installation Requirements.....	15
4.3 Installation Tools .....	16
4.4 Installation Procedures .....	17
4.4.1 Pre-installation Check .....	17
4.4.2 Transportation and Installation .....	18
4.5 Assembling PCS.....	22
<b>5 Powering on and off the Battery System .....</b>	<b>24</b>
5.1 Check before power-on.....	24
5.1.1 Routine Check.....	24
5.1.2 Battery cabinet installation inspection .....	25
5.1.3 Intra-cabinet inspection .....	25
5.2 Power on/off the equipment.....	25



5.2.1 Power-on procedure .....	25
5.2.2 Commissioning .....	26
5.2.3 Power-off procedure .....	26
5.3 Electrical schematic .....	26
<b>6 Maintenance Guide .....</b>	<b>27</b>
6.1 Preparation .....	27
6.2 Replacing the BM or the CM .....	27
6.3 System Failure Information List and Troubleshooting Suggestions .....	27
6.4 Extension .....	29
6.5 System Maintenance .....	30
6.5.1 Safety Precautions .....	30
6.5.2 Post-Maintenance Work .....	30
6.5.3 System Cleaning .....	32
<b>7 Technical Specifications.....</b>	<b>33</b>
7.1 AXE 1000100-C1 (Control Module).....	33
7.2 AXE 5.0H-E1 EU (Battery Module) .....	33
7.3 System Date .....	34
7.4 Battery System Designation.....	36
<b>Appendix I .....</b>	<b>37</b>
<b>Appendix II.....</b>	<b>40</b>

# 1 Product Overview

## 1.1 Intended Use

The entire AXE 50.0~60.0H-1HT-S1 High Voltage Battery System includes a AXE 1000100-C1 (high voltage controller) and multiple AXE 5.0H-E1 EU (battery pack). Each AXE 5.0H-E1 EU consists of 100Ah cells which form 51.2V voltage battery pack via one parallel and sixteen serial connection (1P16S). Three to twelve AXE 5.0H-E1 EU can be connected in serial to extend the capacity and power of energy storage system.

The AXE battery system powers the loads through PCS at nighttime without solar; when solar becomes available during daytime, solar energy powers the loads as a priority and store residual solar power into the AXE battery system.

## 1.2 Appearance

### 1.2.1 Battery Cabinet

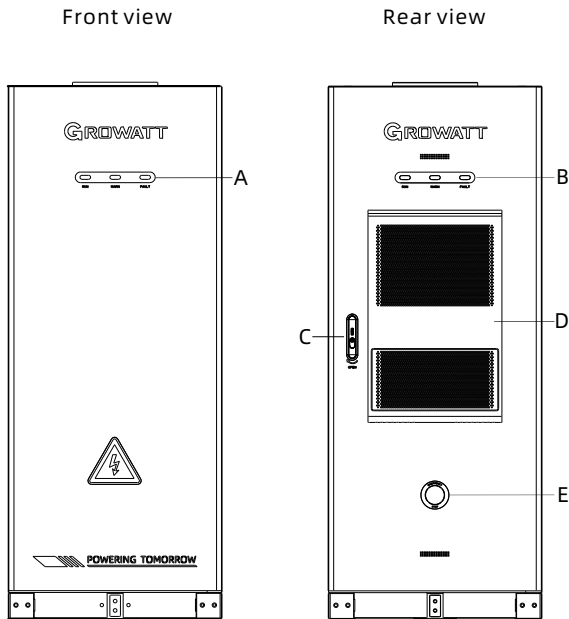

Fig 1.1 The panels of the battery cabinet

NO.	Component	Description
A	LED indicator of front	Indicates the operating status of the energy storage system Green: running normally; yellow: alarm; red: fault
B	LED indicator of back	Indicates the operating status of the energy storage system Green: running normally; yellow: alarm; red: fault
C	Lock	Safety gear
D	Air conditioner	Regulates temperature and humidity inside the cabinet.
E	Emergency stop	Emergency power off

The battery cabinet supports a maximum of 12 battery modules.

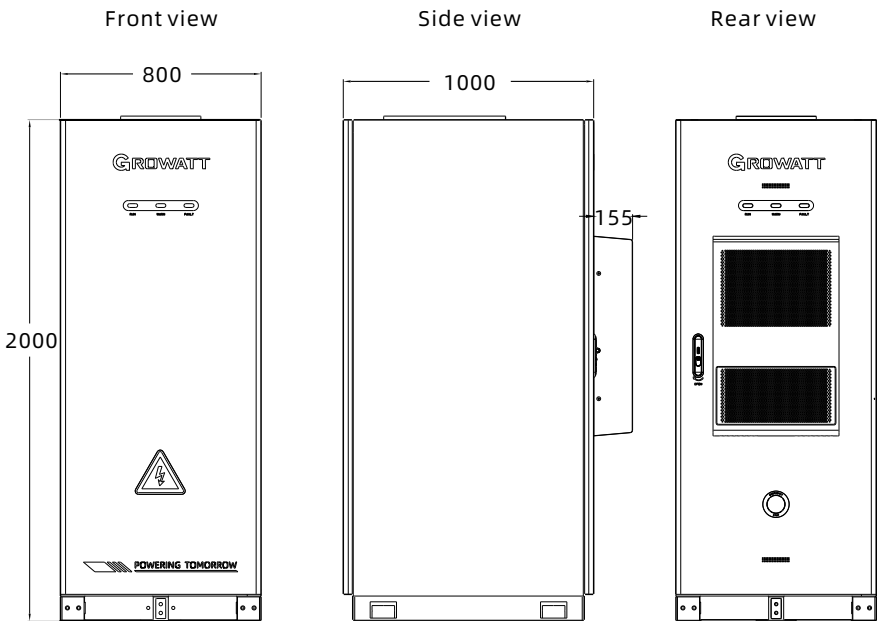

Figure 1.2 Dimensions of the Battery cabinet

### 1.2.2 Intra-cabinet Components

The Intra-cabinet components appearance of the product is shown below.

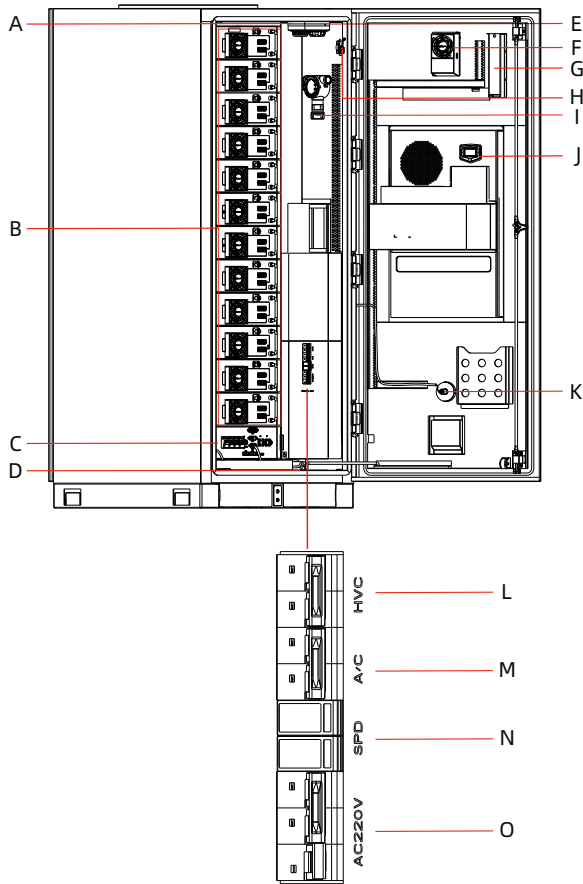

Figure 1.3 The panels of the intra-cabinet components

Position	Module	Description
A	Temperature sensor	Temperature detection
B	Battery pack	Energy storage device
C	High voltage box	Battery charge/discharge control device
D	Water leak sensor	Water leak detection

Position	Module	Description
E	Smoke sensor	Smoke detection
F	Hydrogen Exhaust System	Exhaust of combustible gases from the cabinet
G	Aerosol	For firefighting
H	Access Control Sensor	Monitoring of door opening and closing status
I	Combustible gas detection sensor	Combustible gas detection
J	Air conditioner	Regulates temperature and humidity inside the
K	Emergency stop	Emergency power off
L	HVC	High voltage box power input terminal
M	A/C	Air conditioner power input terminal
N	SPD	SPD (Surge Protective Device) input control terminal
O	AC220V	220VAC power input terminal

### 1.2.3 AXE 1000100-C1 (Control Module)

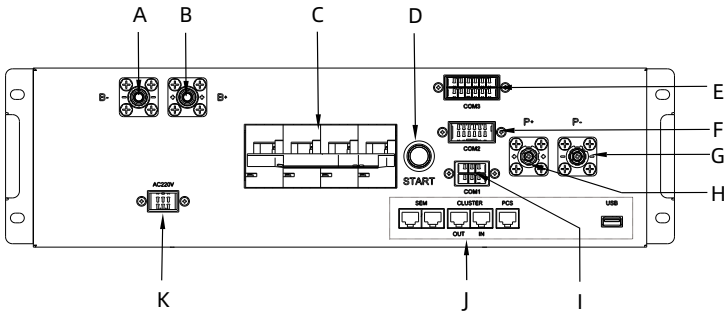

Figure 1.4 Front view of the AXE 1000100-C1

Position	Item	Description
A	BAT- power terminal	Connected to the negative power terminal of the battery cluster
B	BAT+ power terminal	Connected to the positive power terminal of the battery cluster
C	Circuit breaker	To control the battery output

Position	Item	Description
D	Start button	To power on the energy storage system
E	COM3 communication terminal	Connected to the communication port of the battery pack's BM board ,FAN 24V power supply port and heating film power line
F	COM2 communication terminal	Connected to panel indicators, tripping control board and emergency stop switch, etc
G	PCS- power output terminal	Connected to the negative terminal on the DC side of the PCS
H	PCS+ power output terminal	Connected to the positive terminal on the DC side of the PCS
I	COM1 communication terminal	Connected to the RS485 communication port and the 24V power supply port of the EM (Environmental Monitor) board
J	Common wiring terminals	Connected to communication terminals of PCS, SEM and USB
K	Power supply port	Auxiliary AC 220V power input

#### 1.2.4 AXE 5.0H-E1 EU (Battery Module)

The AXE 5.0H-E1 EU Battery Module (BM) consists of battery cells, cooling fan, mechanical parts, Battery Management Unit (BMU) as well as power and communication terminals. The appearance of the product is shown below.

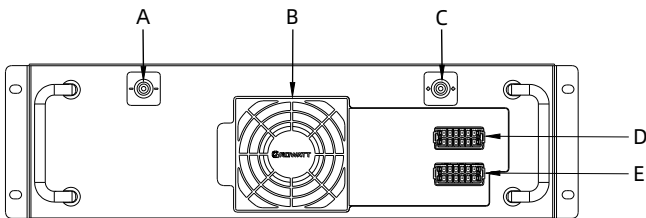

Figure 1.5 Front view of the AXE 5.0H-E1 EU

Position	Item	Description
A	Negative battery pack terminal	Negative battery pack connector
B	Cooling fan	For battery heat dissipation

Position	Item	Description
C	Positive battery pack terminal	Positive battery pack connector
D	COM1 communication terminal	For communication between battery packs, FAN power supply and Heating film power line loop
E	COM2 communication terminal	For communication between battery packs, FAN power supply and Heating film power line loop

### 1.3 Working Principle and Function

The high voltage battery system is composed of a high voltage controller AXE 1000100-C1 and battery pack AXE 5.0H-E1 EU in series. It contains electrochemical batteries, battery control units, battery management units, power and signal terminals, and mechanical parts.

Compared with other battery systems, it has better charging and discharging performance, higher charging and discharging efficiency, more accurate status monitor, longer cycle life and less self-discharge loss.

A single cluster system can connect 3 to 12 packs in series to increase the capacity and power of the battery system. The entire battery system communicates with the inverter through CAN communication, and the operation stability is high.

- Monitoring: voltage, current and temperature detection of both single cells and battery system.
- Protection and Alarm: protection and alarms when over voltage, under voltage, over current, over temperature or under temperature occurs. See Appendix I for the details.
- Report: report all alarms and status data to PCS.
- Series connection: support the series connection of three to twelve Battery Modules.
- Power failure triggered by fault: 10 minutes after the battery system and PCS communication is disconnected or 15 minutes after undervoltage protection.

# 2 Safety

When installing or using a battery system, the safety information contained in this section must always be followed. For safety reasons, it is the installer's responsibility to be familiar with this manual and all warnings before installation.

## 2.1 Basic Security

The battery system has been designed and tested in accordance with strict rules with international safety certification requirements. Before any installation or use of the battery system, please read all safety instructions carefully and always follow the relevant rules. Growatt is not responsible for any of the following circumstances or their consequences:

- Damage occurred during transportation.
- Incorrect transportation, storage, installation and use, or customer fails to convey the correct information about transportation, storage, installation and use to terminal customers.
- Non-professional installation.
- Failure to obey the rules of this operation instructions and safety precautions in this document.
- Unauthorized modifications or removal of the software package.
- The product's tamper label is damaged or the product lacks any parts (except authorized disassembly parts).
- Operation in extreme environments which are not allowed in this document .
- Repair, disassemble, or change packs without authorization and cause failure.
- Damage to shell labels or modifies date of production.
- Packs fail to be charged for more than six months.
- Damages due to force majeure (such as lightning, earthquakes, fire, and storms).
- Warranty expiration.

## 2.2 Safety Precautions

### 2.2.1 Environment Requirements







- Do not expose the battery to temperature above 50°C or heat sources.
- Do not expose the battery to moisture, corrosive gases or liquids.
- Do not expose the battery to direct sunlight for extended periods of time.
- Place battery in safe place away from children and animals.
- Battery power terminals shall not touch conductive objects such as wires.
- Do not dispose the battery in fire, which may cause an explosion.
- The battery system shall not come in contact with liquids.













### 2.2.2 Operation Precautions

- Do not touch the battery system with wet hands.
- Do not disassemble the battery system without permission.
- Do not crush, drop or pierce the battery pack and the high voltage controller.
- Dispose the batteries according to local safety regulations.
- Store and recharge battery in accordance with this manual.
- Ensure the connection of ground wire reliable.
- Remove all metal objects such as watches and rings that could cause a short-circuit before installation, replacement and maintenance.
- The pack shall be repaired, replaced or maintained by skilled personal that has been recognized.
- When storing or handling the battery, do not stack batteries without package.
- Do not broke the battery, the released electrolyte may be toxic and is harmful to skin and eyes.
- Packaged batteries should not be stacked more than specified number stipulated on the packing case.
- Do not use damaged, failed or deformed batteries, which may lead to high temperature or even dangerous accidents. Continued operation of damaged battery may result in electrical shock, fire or even worse.

### 2.3 Warning Labels

Symbols	Description
	Do not dispose in trash
	Lithium ion battery can be recycled
	Certification in European union area
	Electric shock hazard
	Explosive gas
	May leak corrosive electrolyte

Symbols	Description
	Heavy enough to cause severe injury
	Keep the Pack away from children
	Make sure the battery polarity well connected
	Do not expose to fire
	Observe the manual

 <b>GROWATT</b> Lithium Ion Battery	
<b>Model</b>	AXE 5.0H-E1 EU
<b>Nominal Voltage</b>	51.2 V
<b>Nominal/Rated Capacity</b>	100Ah/90Ah
<b>Nominal/Rated Energy</b>	5000Wh/4500Wh
<b>Nominal Current</b>	1C/100A
<b>Operating Temperature</b>	-10°C ~ +50°C
<b>Ingress Protection</b>	IP20
<b>Weight</b>	≤50 kg
<b>Dimensions (W / H / D)</b>	482*131*580mm
    X <span style="float: right;">Made in China</span>	





 <b>GROWATT</b> AXE High Voltage Controller	
<b>Model</b>	AXE 1000100-C1
<b>Operating Voltage Range</b>	120V-1000Vdc
<b>Max. Charge and Discharge Current</b>	100A
<b>Peak Discharge Current</b>	150A, 30s
<b>Operating Temperature</b>	-30°C ~ +65°C
<b>Ingress Protection</b>	IP20
<b>Weight</b>	≤17 kg
<b>Dimensions (W / H / D)</b>	482*129*573mm
    X <span style="float: right;">Made in China</span>	

Figure 2.1 Nameplate

**GROWATT**  
Energy Storage System







---

System Model/ Nominal Voltage/ Nominal Energy / Max Output Power/ Weight /Operating Voltage Range	<input type="checkbox"/> AXE 50.0H-1HT-S1/512V/ 50kWh/50kW/≤0.9t/464-576V  <input type="checkbox"/> AXE 55.0H-1HT-S1/563.2V/ 55kWh/55kW/≤0.95t/510.4-633.6V  <input type="checkbox"/> AXE 60.0H-1HT-S1/614.4V/ 60kWh/60kW/≤1t/556.8-691.2V
--	---

---

Battery Type	LiFePO <sub>4</sub>
Max. Charge and Discharge Current	100A
Operating Temperature	-25°C~+55°C
Protective Class	Class I
Ingress Protection	IP55
Dimensions(W/D/H, mm)	800*1000*2000

---



Download  
Manual



Made in China

Figure 2.2 Nameplate

 <b>WARNING</b>	<p>Performance de-rate may be initiated when the temperature is below 0°C.</p>
---	--

## 2.4 Emergency Responses

Manufacturer takes foreseeable risk scenarios into consideration with the aim of reducing hazards and dangers. However, if the following situation occurs, do as below:

Situation Occurs	Description and action need
Leakage	Avoid touch of leaking liquid or gas. If you touch the leaking electrolyte, do as below immediately. Inhalation: Evacuate the contaminated area, and seek medical help. Eye contact: Rinse eyes with flowing water for 15 minutes, and seek medical help. Skin contact: Rinse contacted area thoroughly with soap and water, and seek medical help. Ingestion: Vomiting, and seek medical help.
On fire	It's hard for battery system ignite spontaneously. If the battery has caught a fire, do not try to extinguish the fire but evacuate people immediately.
Wet Packs	If the battery system is soaked or submerged in water, do not access it. Contact Growatt or distributors immediately for technical assistance.
Damaged shell	Damage to the shell is very dangerous, so special attention must be paid. They are no longer suitable for use and may be dangerous to personnel. If the battery case is damaged, please stop using it and contact Growatt or distributors.

# Storage and Transportation 3

## 3.1 Storage Requirements

- Place the product follow the identification on the packing case during storage.
- Do not put the product upside down or sidelong.
- The defective product needs to be separated from other product.
- The storage environment requirements are as follows:
  - Place the product in a dry, clean and well ventilated place.
  - Keep the battery storage temperature between -20°C~50°C and charge the battery regularly:

Storage temperature	Storage RH	Storage period	Recharge period
<-20°C	/	Not permitted	/
-20°C ~ 25°C	5% ~ 95%	≤12 months	≤12 months
25°C ~ 35°C	5% ~ 95%	≤9 months	≤9 months
35°C ~ 50°C	5% ~ 95%	≤6 months	≤6 months
>50°C	/	Not permitted	/

### Note:

If the battery is not charged when the permitted storage period illustrated above is exceeded, it might result in battery damage. Currently, the battery can only be charged via the inverter.

- Place the product away from corrosive and organic substances (including gas exposure).
- Free from direct exposure to sunlight and rain.
- At least two meters away from heat sources (such as a radiator).
- Free from exposure to intensive infrared radiation.
- If the battery is over-discharged, recharge it to 40% SOC within 7 days.



**NOTICE**



If not follow the above instructions for long-term storage, the battery cycle life will be reduced or even damaged.

## 3.2 Transportation Requirements

➤ Battery pack has been certified in UN38.3 (Section 38.3 of the sixth Revised Edition of the Recommendations on the Transport of Dangerous Goods: Manual of Tests and Criteria) and SN/T 0370.2-2009 (Part 2: Performance Test of the Rules for the Inspection of Packaging for Exporting Dangerous Goods). Battery pack is classified as category 9 dangerous goods.

- The battery pack shall not be transported with other inflammable, explosive or toxic substances.
- Ensure the original Package and label complete and recognizable.
- Prohibit direct exposure to sunlight, rain, condensing water caused by temperature difference and mechanical damages.
- Prohibit to pile up more than twelve battery pack.
- There will be a drop in capacity during transportation and storage.
- Transportation temperature is between -20°C to 50°C, relative humidity: 5%~95%RH.

# Installation 4

 <p><b>WARNING</b></p>	<ul style="list-style-type: none"><li>➤ The installation and use of batteries involve a lot of expertise. Therefore, please ensure that technicians have obtained relevant technical certificates before operation.</li><li>➤ Ensure to read the Guidance before installation in order to understand product information and safety cautions.</li><li>➤ Operators should be well trained technicians and fully understand the whole photovoltaic system, grid network, battery system, working principle and national regional standards.</li><li>➤ Installers must use insulating tools and wear safety equipment.</li><li>➤ Device damages caused by failure to comply with storage, transportation, installation and use requirements specified in Guidance are not covered by Warranty.</li><li>➤ Do not install or use battery near explosive or inflammable substances.</li><li>➤ Use battery in well-ventilated environment with temperature ranging from -10°C to 50°C, recommended operating temperature 10°C~30°C. When the ambient temperature is higher than 45°C or lower than 10°C, the battery's charge and discharge power may be derated.</li><li>➤ Maintain a minimum level of dust and dirt in the environment.</li><li>➤ Do not install battery in highly humid area such as bathroom.</li><li>➤ Please make sure that all battery pack connected in series are from the same batch, the same model and the same manufacturer. Do not mix old batteries with new batteries. Batteries undergone less than 300 cycles are defined as new batteries.</li></ul>
 <p><b>NOTICE</b></p>	<ul style="list-style-type: none"><li>➤ Before installing in series, make sure that the voltage difference of the battery pack must be less than or equal to 0.5V.</li><li>➤ When installing the batteries, we recommend that the manufacturing date of batteries in the same system should be within 3 months.</li></ul>

## 4.1 Installation Environment

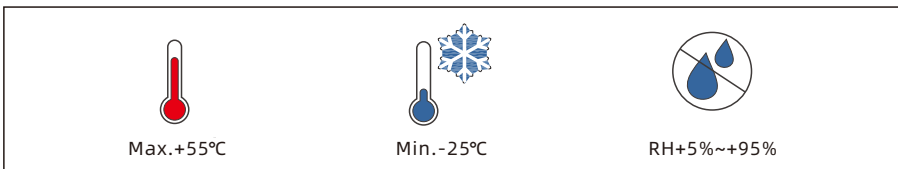

Fig 4.1 Installation environment requirement

## 4.2 Basic Installation Requirements

Energy Storage System Installation Environmental Requirement:

The ESS may corrode if installed in areas with salt damage or pollution. The ESS is suitable for the following or better environments:

- 1) Outdoor environments more than 2000 meters away from the coast: Installation within 2000 meters of the coast is not recommended. (If installation is necessary, consult with the distributor or our company's engineer for confirmation).
- 2) More than 3000 meters away from heavy pollution sources such as smelters, coal mines, and thermal power plants.
- 3) More than 2000 meters away from moderate pollution sources such as chemical plants, rubber factories, and electroplating facilities.
- 4) More than 1000 meters away from light pollution sources such as food processing plants, leather factories, heating boilers, slaughterhouses, centralized garbage dumps, and sewage treatment stations.

➤ A single cabinet: For maintenance purposes, please leave a clearance of not less than 600 mm from the back door of the cabinet, as shown in the figure below.

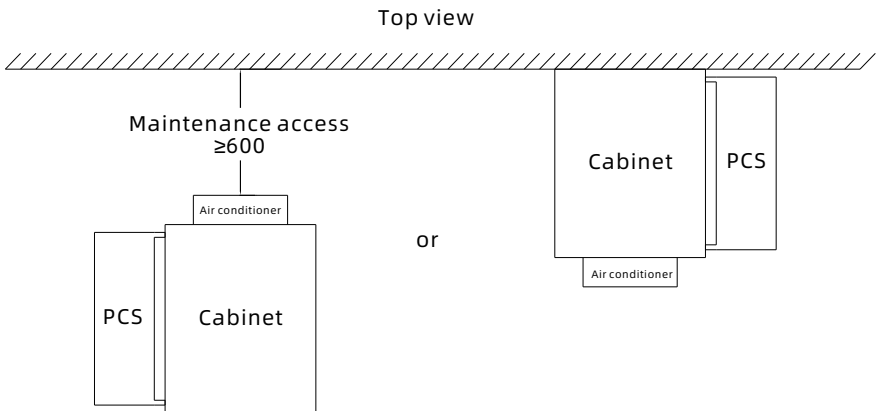

Figure 4.2 Top view



- Multiple cabinets in parallel: A maximum of 4 cabinets can be configured in parallel and the cabinets can be mounted side by side with no gap in between. The figure below takes the configuration of three cabinets in parallel working with the PCS (WIT-30-55K-XHU) as an example:

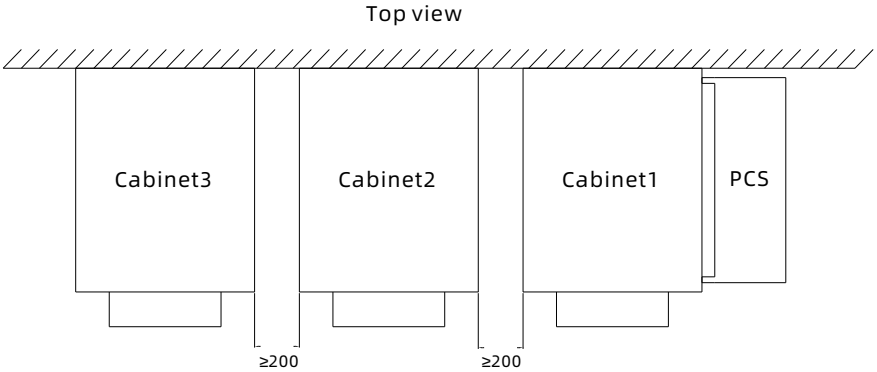

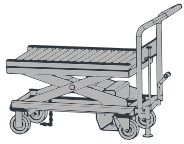

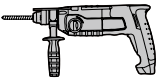

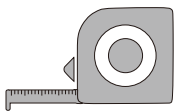



Figure 4.3 Top view

### 4.3 Installation Tools

 <p>Forklift</p>	 <p>Lifting trolley</p>	 <p>working with M6/M8 bit holders &amp; P2 Phillips bit</p> <p>Electric screwdriver</p>
 <p>working with 16 mm drill bit</p> <p>Impact drill</p>	 <p>Hammer</p>	 <p>Marker</p>
 <p>Measuring tape</p>	 <p>Wrench</p>	 <p>Knife</p>

## 4.4 Installation Procedures

### 4.4.1 Pre-installation Check

- Check the PACK package before open it. If any abnormality is detected, do not open the package and contact your distributor.
- Check and confirm the PACK is powered off before installation.
- Check the quantity of all parts inside according to the package list. If there is any part missing or damaged, please contact your distributor.

#### 4.4.1.1 Check the scope of delivery

No.	Item	Qty
1	Battery cabinet	1
2	Battery pack	Configured based on customer's needs
3	High voltage box	1
4	Quick Guide	1
5	User Manual	1
6	Certificate of Conformity	1
7	Desiccant	2

#### 4.4.1.2 Check the accessories

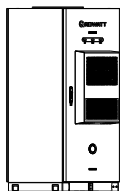

Battery cabinet  
X1

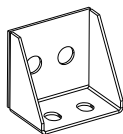

Anchor bracket  
X1



Cable set  
X1



Sealing clay  
X1



Desiccant  
X2



Expansion bolt  
X8



M12\*60 screw  
X10



M10\*30 screw  
X4



M6\*16 screw  
X4



Quick installation guide  
X1

## 4.4.2 Transportation and Installation

### 4.4.2.1 Level the foundation

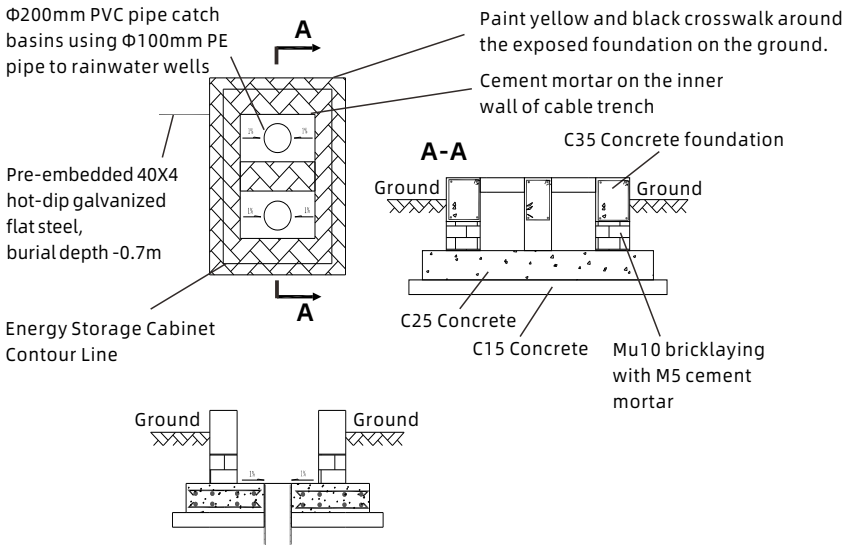

Figure 4.4 Leveling the foundation process

### 4.4.2.2 Drill holes into the ground

- Step 1: Mark hole positions at the pre-determined installation location according to the dimensions indicated below.
- Step 2: Drill holes at the marked positions.
- Step 3: Insert the expansion bolts into the holes.
- Step 4: Tighten the bolts to expand the sleeve.
- Step 5: Remove the bolts.

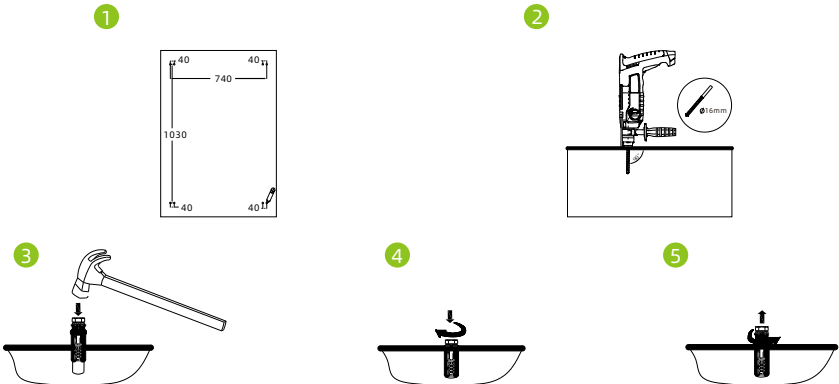
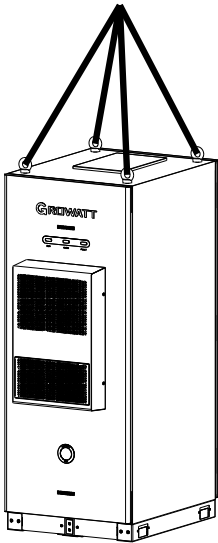

Figure 4.5 Ground drilling process

### 4.4.2.3 Adopt lifting to transport the cabinet

On-site transportation of cabinets can be used lifting or forklift according to the actual situation.

Pass the lifting rope through the 4 rings on the top of the cabinet, use the lifting equipment to lift the cabinet by the lifting rope and move it to the designated position. During the process, keep it stable and prevent it from shaking.



Please make sure the lifting rope is long enough to make the angle of projection of the lifting rope in the vertical plane between the two rings is less than  $90^\circ$ .

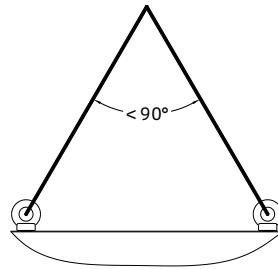

Figure 4.6 lifting transport process

### 4.4.2.4 Moving the equipment with a forklift

secure it properly according to the actual situation to avoid tip-overs.

Note: Forklifts cannot transport racks with batteries installed.

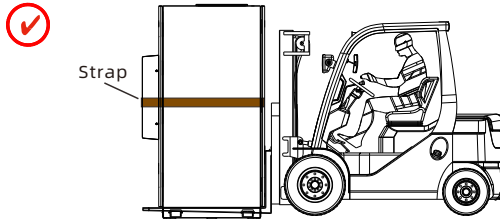
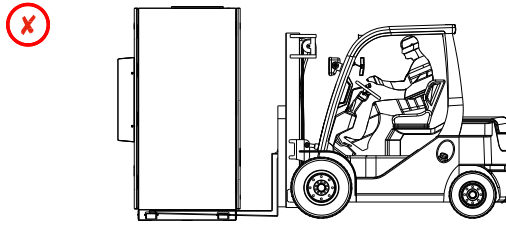

Figure 4.7 Forklift transport process

#### 4.4.2.5 Preparation before installing cabinets

Step 1: Check the appearance of the cabinet for good condition.

Step 2: Loosen the screws. Remove the front and rear covers of the base.

Step 3: Remove the pallet after the cabinet has been lifted.

1

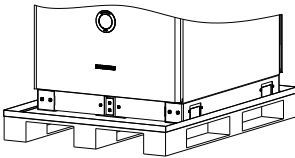

2 Remove the front and rear covers of the base

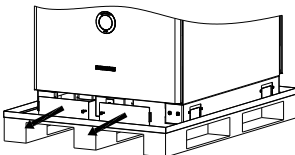

3 Remove the pallet

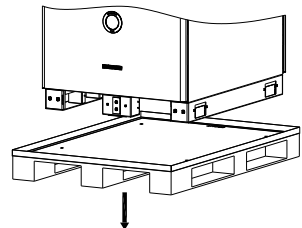

Figure 4.8 Cabinet installation preparations

4.4.2.6 Install the cabinet on the foundation

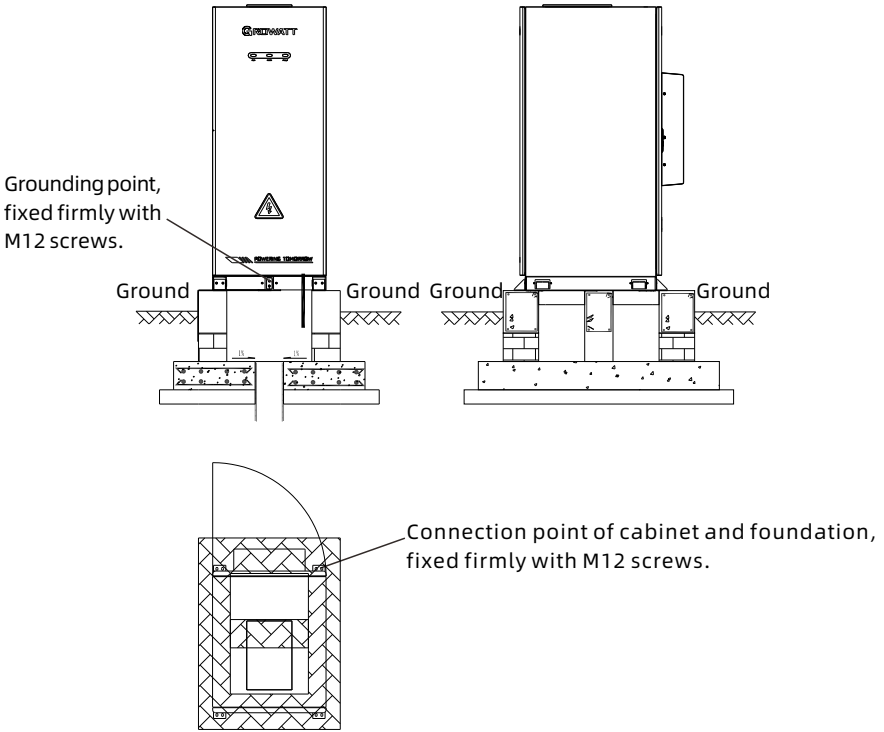

Figure 4.9 Install the cabinet on the foundation process

## 4.5 Assembling PCS

This cabinet is compatible with various PCS.  
Take connecting to the WIT30-55K as an example.

Step 1: Assemble the PCS bracket

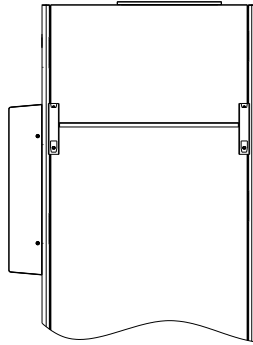

Figure 4.10 Step 1 Assemble the PCS

Step 2: Use the tool to lift the PCS and hang it on the bracket. Tighten the screws

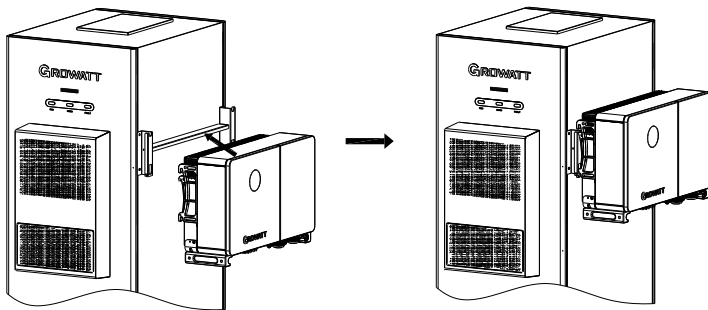

Figure 4.11 Step 2 Assemble the PCS

Step 3: The single cabinet side mount PCS is as follows, connecting the cables

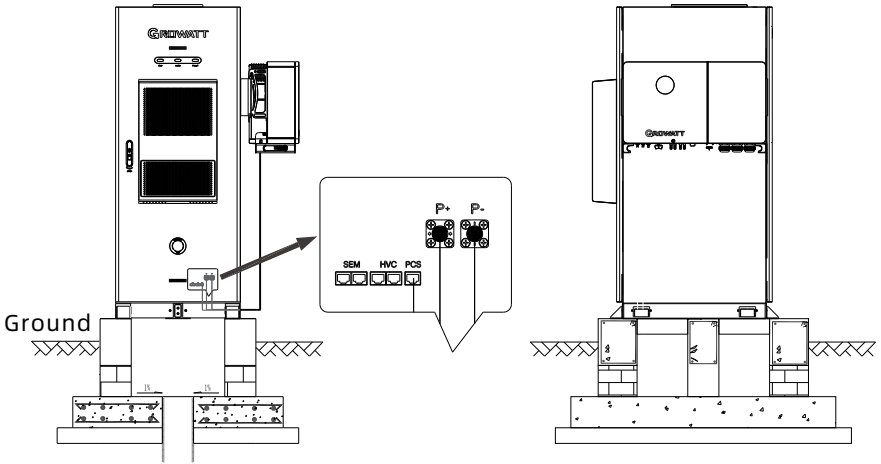

Figure 4.12 Step 3 Assemble the PCS

Step 4: WIT 29.9-50K-XHU supports the connection of up to 3 energy storage cabinets in parallel.

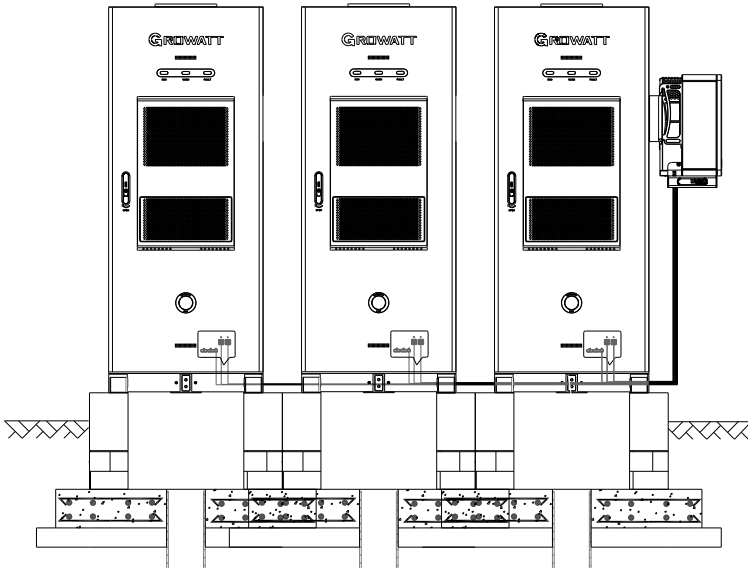

Figure 4.13 Step 4 Assemble the PCS



# Power on and off the Battery 5 System



**NOTICE**

- The installation and use of batteries need to be operated by professional technicians.
- Do not contact any positions with potential difference.
- Prohibition sign should be hung on the battery: " Non - professionals, do not touch.
- If any abnormalities occur during the startup phase, power off the system immediately. After problem confirmed, proceed again.
- Make sure the inverter is turned off before checking the battery system.

## 5.1 Check before power-on

### 5.1.1 Routine Check

No.	Checking item	Acceptance criteria
1	Equipment appearance	<ul style="list-style-type: none"> <li>• The equipment is intact, free from damage, rust or paint loss. If the paint flakes off, please re-paint the spotted area.</li> <li>• Equipment labels are clear and damaged labels should be replaced in time.</li> </ul>
2	Cable appearance	<ul style="list-style-type: none"> <li>• The cable sheath is properly wrapped with no visible damage.</li> <li>• The cable conduits are intact.</li> </ul>
3	Cable connection	<ul style="list-style-type: none"> <li>• Cables are connected at the designate positions.</li> <li>• Wiring terminals are prepared as required and connected reliably.</li> <li>• Labels on both end of each cable is clear and facing toward the same direction.</li> </ul>
4	Cable routing	<ul style="list-style-type: none"> <li>• Electrical cables and extra low voltage cables are routed separately.</li> <li>• The cables are neat and tidy.</li> <li>• Cable tie joints are evenly cut without burs.</li> <li>• Leave the cable slack at bending points to avoid stress.</li> <li>• Cables are routed neatly without twists or crossovers in the cabinets.</li> </ul>

### 5.1.2 Battery cabinet installation inspection

Cabinet inspection:

No.	Checking item	Acceptance criteria
1	Installation	<ul style="list-style-type: none"> <li>• Installation complies with the design requirements.</li> <li>• The cabinet is level, and each door opens properly.</li> </ul>
2	Appearance	<ul style="list-style-type: none"> <li>• The surface of the cabinet is free from cracks, dents and scratches. If the paint flakes off, re-paint the spotted area.</li> </ul>
3	Cabinet grounding	<ul style="list-style-type: none"> <li>• Each cabinet has at least two grounding points and should be grounded reliably. The site ground resistance should be less than or equal to 0.1Ω.</li> </ul>
4	Label	<ul style="list-style-type: none"> <li>• Labels are correct, clear and complete.</li> </ul>

### 5.1.3 Intra-cabinet inspection

No.	Checking item	Acceptance criteria
1	Circuit breaker	The circuit breakers are OFF.
2	Cable	The bolts for securing the cables have been tightened and no loose cable connections.
3	Battery packs	All battery packs are intact.
4	Foreign object	Foreign objects, such as tools and installation leftovers are removed from the cabinet.
5	Cabinet grounding	The grounding conductor is reliably connected to the cabinet's grounding terminal block or copper bar.

## 5.2 Power on/off the equipment

### 5.2.1 Power-on procedure

1	Test the voltage between BAT+ and BAT- with a multimeter.	Voltage range: 603.2 -738.4V
2	Turn on the HVC's DC load switch	
<p>a: Before turning on the internal switches of the auxiliary power supply in the energy storage system, ensure that the AC auxiliary power supply voltage is within the normal range (220V+10%).</p>		

### 5.2.2 Commissioning

**Prerequisites:**

1	All devices on site have passed the on-site tests.
2	The system has been powered on and no alarm/fault is reported.
3	The commissioning tools are available on site.

### 5.2.3 Power-off procedure

1	Turn off the AC power supply, including the HVC and socket
2	Turn off the main breaker of the auxiliary power supply in the AC distribution box.
3	Turn off the HVC's DC load switch.
4	Turn off the DC circuit breaker of the high voltage box.

## 5.3 Electrical schematic

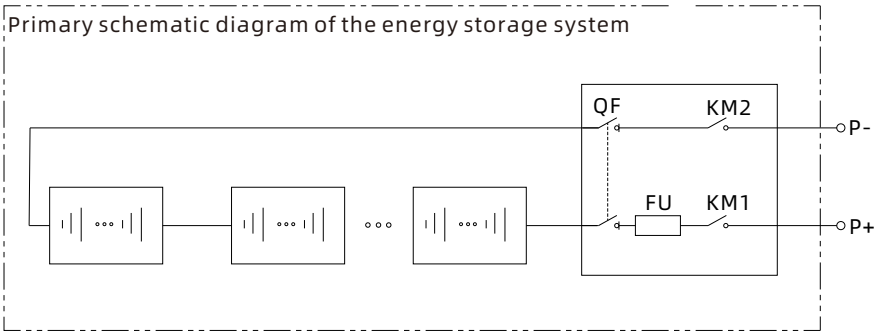

Figure 5.1 Primary schematic diagram of the energy storage system

# 6 Maintenance Guide

## 6.1 Preparation

Before maintenance, please make sure that the battery system is powered off and the DC circuit breaker is off.

## 6.2 Replacing the BM or the CM



### NOTE:



Replace the battery if the following conditions occur: The internal circuit of the battery expansion module is faulty, the battery health reaches the end point, the battery appearance is deformed, damaged, or leaks.



- Wear safety gloves.
- Close the breaker and power off the battery system.
- Disconnect power lines and CAN communication lines of the battery system.
- Uninstall the safety screws on both sides of the battery pack or high voltage controller. Lift up the battery pack or high voltage controller.
- Put the battery pack or high voltage controller into the packing box according to the repair procedure and transport the battery pack or high voltage controller to the designated repair site.
- Install new battery pack or high voltage controller based on procedure specified in Section 4.

 <b>NOTICE</b>	<p>➤ If the battery is not used, it is recommended to charge and discharge the battery every 3 months to activate the chemical characteristics, and the maximum interval shall not exceed 6 months.</p>
--	---

## 6.3 System Failure Information List and Troubleshooting Suggestions

Error Indication		Error description	Error cause	Suggested actions
FAULT LED	START LED			
 ( FAULT Light Flickers)	 ( START Green Light Flickers)	Discharge under voltage protection	Single cell voltage below the threshold for under-voltage protection	There is over-discharged risk. User should stop discharging and arrange recharge

Error Indication		Error description	Error cause	Suggested actions	
FAULT LED	START LED				
 (FAULT Light Flickers)	 (START Green Light Flickers)	Charge over voltage protection	Single cell voltage exceeding threshold for protection threshold.	1. There is no safety threat; 2. User should stop charging. Wait for the battery system to automatically resolve the fault	
		High temperature protection	The temperature exceeds the protection value	It is dangerous, please stop using the battery immediately, wait for the battery temperature to drop the fault will be automatically resolved	
		Low temperature protection	The temperature is below the protection value	No safety risk, wait for the temperature to rise, the fault will be automatically resolved.	
	 (START Red Light Flickers)	Discharge short circuit	External short circuit of battery system	Communication loss between PCS and battery system	1. There is no safety threat and user should stop using battery. 2. Check if PCS and battery communication terminal is well connected. 3. If PCS and battery system cannot communicate when the communication wire is confirmed well connected, user should contact installer to repair battery.
		Precharge short circuit			
		Precharge overtime			
External CAN Communication failure					

Error Indication		Error description	Error cause	Suggested actions
FAULT LED	START LED			
 (FAULT Light Flickers)	 (START Red Light on)	Interior Communication failure	Communication loss between two packs	1. Check whether the communication line between the battery pack and the battery pack is connected OK; 2. Check whether the communication line between the high voltage controller and the battery pack is connected OK.
		Voltage sampling anomaly protection	BMS Voltage sampling failure	There is safety risk and user should stop using battery. User should contact installer to repair battery.
		Current sampling fault	BMS current sampling failure	
		Main circuit fault	BMS main power circuit failure	There is safety risk and user should stop using battery. User should contact installer to repair battery.

## 6.4 Extension

New Battery Selection:

- 1) The battery should be of the same model.
- 2) The interval between the installation date and the production date of new battery models should not exceed half a year.
- 3) The installation interval between the new battery and the original system battery should be shorter than or equal to one year.

Steps to Add the New Battery Module:

- 1) Configure the system to enter expansion mode and wait until the system SOC is discharged to 35%.
- 2) Turn off the inverter and battery and wait at least 5 minutes to ensure there is no voltage.
- 3) Connect the new battery module to the system.
- 4) Start the system and enable the one-click diagnostic function.
- 5) After the test is OK, disable the diagnostic function and expansion mode, and the module SOC will automatically balance within a few weeks.

**Note:**

1. If not follow this guide, the battery system performance will be affected or even unable operate properly.
2. If the new battery module SOC and the existing system are not at same level, the battery system capacity will be limit and SOC jumps.

## 6.5 System Maintenance

### 6.5.1 Safety Precautions

The interior of the energy storage cabinet contains lethal high voltage. Accidental contact may result in fatal electric shock.

- After shutdown, wait at least 10 minutes before opening the cabinet door. Ensure the equipment is completely de-energized before performing maintenance.
- Qualified Personnel: Only authorized and qualified personnel are permitted to perform maintenance on the energy storage cabinet.
- Operational Guidelines:
  - 1) Do not leave screws, washers, or other metal parts inside the cabinet during maintenance to avoid equipment damage.
  - 2) Environmental Requirements:
    - Sandstorms or moisture may damage electrical components or degrade performance.
    - Prohibited Conditions: Do not open the cabinet during sandstorms or when ambient relative humidity exceeds 95%.
    - Maintenance should only be conducted in dry, sandstorm-free weather.
  - 3) Power Disconnection Verification:
    - Disconnect all AC/DC side switches and the cabinet's front/rear circuit breakers.
    - Before maintenance, verify that cable terminals are de-energized to prevent electric shock.

### 6.5.2 Post-Maintenance Work

Air Conditioning Maintenance

**WARNING:** All maintenance must be performed by qualified professionals.

Disconnect the AC power and signal lines before any operation, and reconnect them after completion.

Inspection Item	Procedure Description	Maintenance Interval
Wiring	Visual inspection for loose connections	1 year
Fan Abnormalities	Rotate the fan to check smoothness and noise	1 year
Condenser	Inspect cleanliness; clean with compressed air	6 months

## Other Maintenance Items

Inspection Item	Procedure Description	Maintenance Interval
Component Inspection	<ul style="list-style-type: none"> <li>• Routine inspection of all metal components</li> <li>• Verify equipment operating parameters</li> </ul>	6 months
Internal Components	<ul style="list-style-type: none"> <li>• Clean dust from circuit boards and components</li> <li>• Clean AC filter</li> <li>• Clean fan dust</li> </ul>	6 months
Safety Functions	<ul style="list-style-type: none"> <li>• Inspect safety warning labels for damage and replace them if damaged</li> <li>• Test emergency stop functionality</li> </ul>	6 months
Exterior Inspection	<ul style="list-style-type: none"> <li>• Check for shell damage or corrosion</li> <li>• Verify installation stability</li> <li>• Check whether the cabinet door can be opened and closed properly</li> <li>• Inspect surrounding hazards</li> </ul>	1 year
Interior Inspection	<ul style="list-style-type: none"> <li>• Remove debris and dust</li> <li>• Check for loose screws</li> </ul>	1 year
Cabling Inspection	<ul style="list-style-type: none"> <li>• Verify cable connections and layout</li> <li>• Inspect insulation sleeves for damage and whether the screws are loose</li> <li>• Check cable port seals</li> </ul>	1 year
System Status	<ul style="list-style-type: none"> <li>• Monitor abnormal noise/vibration</li> <li>• Check temperature/humidity</li> <li>• Inspect for damage/rust</li> <li>• Clear outlet blockages</li> <li>• Inspect surge protectors and fuses</li> </ul>	2 years

### Notes:

- Recommended intervals may vary based on installation environment (e.g., sandstorms, dust). Please determine the maintenance cycle reasonably according to the actual installation environment.
- Harsh environments require shorter intervals and increased frequency.



### **6.5.3 System Cleaning**

Regular cleaning is essential for outdoor energy storage cabinets to remove surface contaminants and internal dust. This enhances heat dissipation, reduced shell corrosion, reduces energy consumption, prolongs lifespan, and minimizes safety risks.

1) Exterior Cleaning:

- Wipe surfaces with a cloth or mop. Avoid water entering vents.

2) Interior Cleaning:

- Do not use brooms (to prevent dust dispersion). Use a vacuum cleaner instead.

3) Lock & Hinge Inspection:

- After cleaning, test door locks and lubricate if necessary.

4) Seal Inspection:

- Ensure sealing strips are intact. Replace immediately if damaged.

# 7 Technical Specifications

## 7.1 AXE 1000100-C1 (Control Module)

NO.	Items	Specifications
1	Model	AXE 1000100-C1
2	Input/output voltage range	120V-1000Vdc
3	Rated current	100A
4	Operating ambient temperature	-10~50°C
5	IP rating	IP20
6	Communication method	CAN/Daisy chain/RS485/USB
7	Dimensions (W/D/H)	W482*D580*H131mm
8	Weight	≤15Kg
9	Certification	CE/IEC62619/IEC62477
10	Environment requirements	RoHS

## 7.2 AXE 5.0H-E1 EU (Battery Module)

NO.	Items	Specifications
1	Battery pack Module	AXE 5.0H-E1 EU
2	Nominal Capacity/Energy	100Ah / 5kWh
3	Rated Capacity/Energy	90Ah / 4.5kWh
4	Nominal Voltage	51.2V
5	Operating Voltage	46.4~57.6V
6	Rated current(25°C)	100A
8	Battery Type	Cobalt Free Lithium Iron Phosphate (LFP)
9	Operating ambient temperature	-10~50°C
10	Storage conditions	Temperature: -20°C~25°C/12 months; 25°C~35°C/9 months; 35°C~50°C/6 months; Humidity: 5%~95%RH
11	Cooling	Air-Cooling
12	Dimensions (W/D/H)	W482*D580*H131mm

NO.	Items	Specifications
13	Weight	≤47kg
14	Installation	Floor stand
15	Ingress protection	IP20
16	Cell safety certification	IEC62619/UL1973
17	safety certification	UN 38.3/IEC 62619/IEC 60730/IEC 62477/CE/ROSH
18	Transportation test standard	UN38.3
19	Environment requirements	RoHS
20	Battery designation	IFpP/51/161/119/[1P16S]M/-10+50/90
21	Cycle life	6000 cycles (@25±2°C, 0.5C, 60%EOL)

### 7.3 System Date

System Model	AXE 50.0H-1HT-S1	AXE 55.0H-1HT-S1	AXE 60.0H-1HT-S1
Energy Capacity	50kWh	55kWh	60kWh
Usable Capacity	45kWh	49.5kWh	54kWh
Rated Power	50kW	55kW	60kW
Max output power	50kW	55kW	60kW
Nominal capacity	100Ah(@25°C)		
Rated capacity	90Ah(@25°C)		
Nominal voltage	512V	563.2V	614.4V
Operating voltage range	464~576V	510.4~633.6V	556.8~691.2V
Dimensions(mm)	High Cabinet: 800*1000*2000mm		
Weight	≤0.9t	≤0.95t	≤1t
Rated current	100A		
Max current	100A		
Fault current	120A		
DoD	90%		

System Model	AXE 50.0H-1HT-S1	AXE 55.0H-1HT-S1	AXE 60.0H-1HT-S1
Operating ambient temperature	-10°C~50°C		
RTE	> 95%		
Battery pack in series	Maximum support 12 units in series, series voltage difference $\Delta V \leq 0.5V$		
Humidity	5%~95%		
Storage conditions	Temperature: -20°C~25°C/12 months; 25°C~35°C/9 months; 35°C~50°C/6 months; Humidity: 5%~95%RH		
Cooling method	Air-Cooling		
Installation	Floor stand		
Altitude	$\leq 2000m$		
Communication method	CAN/Daisy chain/RS485		
Certified product	UN 38.3/IEC 62619/IEC 60730/IEC 62477/CE/ROSH		
Transport certification	UN38.3		
IP rating	Ip55		
Environmental requirements	RoHS		
Battery System	Secondary Li-ion Battery System		
Cycle life	6000 cycles (@25±2°C, 0.5C, 60%EOL)		



**NOTICE**





























- Method for calculating rated capacity:
- Rated capacity of the measured module: 90 Ah
- Number of modules connected in series: 3~12
- Calculated rated capacity (Ah) = 90 Ah \* 1 = 90Ah
- The performance will be limited when the temperature is below 0°C.





















## 7.4 Battery System Designation

























Mode	Battery designation	Recommended charge instructions
AXE 50.0H-1HT-S1	IFpP/51/161/119/[(1 P16S)10S]M/-10+50/90	1.Constant current 100A charging to 540V; 2.Constant current 50A charging to 550V; 3.Constant current 25A charging to 550V; 4.Constant current 10A charging to 550V; 5.Constant current 5A charging to 550V;
AXE 55.0H-1HT-S1	IFpP/51/161/119/[(1 P16S)11S]M/-10+50/90	1.Constant current 100A charging to 594V; 2.Constant current 50A charging to 605V; 3.Constant current 25A charging to 605V; 4.Constant current 10A charging to 605V; 5.Constant current 5A charging to 605V;
AXE 60.0H-1HT-S1	IFpP/51/161/119/[(1 P16S)12S]M/-10+50/90	1.Constant current 100A charging to 648V; 2.Constant current 50A charging to 660V; 3.Constant current 25A charging to 660V; 4.Constant current 10A charging to 660V; 5.Constant current 5A charging to 660V;

# Appendix I

## LED indication Control Mechanism

LED light definition					
Battery System Status	Items	Battery cabinet light display			High voltage box light display
		RUNNING LED Status	WARNING LED Status	FAULT LED Status	START LED Status
StandBy					
Charge					
Discharge					
Update		 (T=1S)	 (T=1S)		 (T=0.4S)
Fault Date export		 (T=1S)	 (T=1S)		 (T=0.4S)
Warning	Cell charge overvoltage warning				 (T=2S)
	PACK charge overvoltage warning				 (T=2S)
	Cell discharge undervoltage warning				 (T=2S)
	PACK discharge undervoltage warning				 (T=2S)
	Charge or discharge high temperature warning				 (T=2S)
	Charge or discharge low temperature warning				 (T=2S)
	Charge or discharge overcurrent warning				 (T=2S)
	Relay high temperature warning				 (T=2S)

LED light definition					
Battery System Status	Items	Battery cabinet light display			High voltage box light display
		RUNNING LED Status	WARNING LED Status	FAULT LED Status	START LED Status
Warning	High temperature environment warning				 (T=2S)
	Cell Large voltage difference warning				 (T=2S)
	Pack Large temperature difference warning				 (T=2S)
Fault	Cell charge overvoltage protection				 (T=2S)
	PACK charge overvoltage protection				 (T=2S)
	Cell discharge undervoltage protection				 (T=2S)
	PACK discharge undervoltage protection				 (T=2S)
	Charge or discharge high temperature protection				 (T=2S)
	Charge or discharge low temperature protection				 (T=2S)
	Charge or discharge overcurrent protection				 (T=2S)

LED light definition					
Battery System Status	Items	Battery cabinet light display			High voltage box light display
		RUNNING LED Status	WARNING LED Status	FAULT LED Status	START LED Status
Fault	Relay high temperature protection				 (T=2S)
	High temperature environment protection				 (T=2S)
	Cell Large voltage difference protection				 (T=2S)
	Pack Large temperature difference protection				 (T=2S)
	Discharge short circuit				 (T=2S)
	Precharge short circuit				 (T=2S)
	Precharge overtime				 (T=2S)
	External CAN communication failure				 (T=2S)
	Interior communication failure				
	Voltage sampling anomaly protection				
	Current sampling fault				
	Main circuit fault				



# Appendix II

## ➤ Barcode coding rules

Bar code number position:

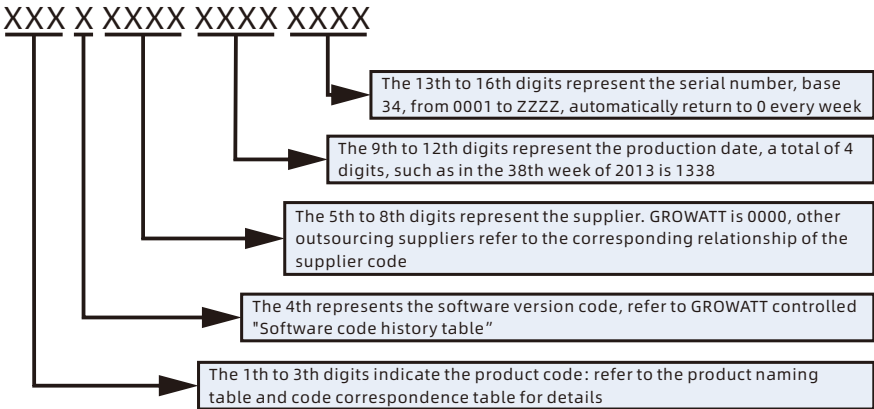

1. The 1th to 3th digits indicate the product code : refer to the product naming table and code correspondence table for details.
2. The 4th represents the software version code , refer to GROWATT controlled "Software code history table".
3. The 5th to 8th digits represent the supplier code. GROWATT is 0000, the supplier D is 0001, and other outsourced suppliers are 0002/0003... , and so on, please refer to the corresponding relationship table of the supplier code.
4. The 9th to 12th digits represent the production date, which is represented by 4 digits, the year is represented by the first 2 digits, and the week is represented by the last 2 digits, for example, the 38th week of 2013 is 1338.
5. The 13th to 16th digits represent the serial number, 34 base , represented by 4 digits, and the characters 0 to Z are used. I and O in the letters are discarded. For example, the product number is SD00.0002100, the product code is ARJ, the software version is 0, the supplier D is 0001, the production date is 21th week in 2021, and the first barcode of the work order is ARJ0000121210001.





Download  
Manual





Shenzhen Growatt New Energy Co., Ltd.  
4-13/F, Building A, Sino-German (Europe) Industrial Park,  
Hangcheng Blvd, Bao'an District, Shenzhen, China

**E** [service@growatt.com](mailto:service@growatt.com)

**W** [en.growatt.com](http://en.growatt.com)

For local customer support, please visit <https://en.growatt.com/support/contact>

GR-UM-491-A-00 (PN: 044.0139400)